

MultiPlus (with firmware xxxx400 or higher)

12 | 3000 | 120 - 50 | 120V

24 | 3000 | 70 - 50 | 120V

1. SAFETY INSTRUCTIONS

In general

Please read the documentation supplied with this product first, so that you are familiar with the safety signs and directions before using the product.

This product is designed and tested in accordance with international standards. The equipment should be used for the designated application only.

WARNING: DANGER OF ELECTRICAL SHOCK

The product is used in combination with a permanent energy source (battery). Even if the equipment is switched off, a dangerous electrical voltage can occur at the input and/or output terminals. Always switch the AC power off and disconnect the battery before performing maintenance.

The product contains no internal user-serviceable parts. Do not remove the front panel and do not put the product into operation unless all panels are fitted. All maintenance should be performed by qualified personnel.

Never use the product at sites where gas or dust explosions could occur. Refer to the specifications provided by the manufacturer of the battery to ensure that the battery is suitable for use with this product. The battery manufacturer's safety instructions should always be observed.

WARNING: do not lift heavy objects unassisted.

Installation

Read the installation instructions before commencing installation activities.

This product is a safety class I device (supplied with a ground terminal for safety purposes). **Its AC input and/or output terminals must be provided with uninterruptible grounding for safety purposes. An additional grounding point is located on the outside of the product.** If it can be assumed that the grounding protection is damaged, the product should be taken out of operation and prevented from accidentally being put into operation again; contact qualified maintenance personnel.

Ensure that the connection cables are provided with fuses and circuit breakers. Never replace a protective device by a component of a different type. Refer to the manual for the correct part.

Check before switching the device on whether the available voltage source conforms to the configuration settings of the product as described in the manual.

Ensure that the equipment is used under the correct operating conditions. Never operate it in a wet or dusty environment. Ensure that there is always sufficient free space around the product for ventilation, and that ventilation openings are not blocked. Install the product in a heatproof environment. Ensure therefore that there are no chemicals, plastic parts, curtains or other textiles, etc. in the immediate vicinity of the equipment.

Transport and storage

On storage or transport of the product, ensure that the mains supply and battery leads are disconnected.

No liability can be accepted for damage in transit if the equipment is not transported in its original packaging.

Store the product in a dry environment; the storage temperature should range from -20°C to 60°C .

Refer to the battery manufacturer's manual for information on transport, storage, charging, recharging and disposal of the battery.

2. DESCRIPTION

2.1 In general

The basis of the MultiPlus is an extremely powerful sine inverter, battery charger and automatic switch in a compact casing. The MultiPlus features the following additional, often unique characteristics:

Automatic and uninterruptible switching

In the event of a supply failure or when the generating set is switched off, the MultiPlus will switch over to inverter operation and take over the supply of the connected devices. This is done so quickly that operation of computers and other electronic devices is not disturbed (Uninterruptible Power Supply or UPS functionality). This makes the MultiPlus highly suitable as an emergency power system in industrial and telecommunication applications. The maximum alternating current that can be switched is 16A or 50A, depending on model.

Auxiliary AC output

Besides the usual uninterruptible output, an auxiliary output is available that disconnects its load in the event of battery operation. Example: an electric boiler that is allowed to operate only if the genset is running or shore power is available.

Virtually unlimited power thanks to parallel operation

Up to 6 Multis can operate in parallel. Six units 24/3000/70, for example, will provide 15kW / 18kVA output power and 420 Amps charging capacity.

Three phase capability

Three units can be configured for three-phase output. But that's not all: up to 6 sets of three units can be parallel connected to provide 45kW / 54kVA inverter power and more than 1000A charging capacity.

PowerControl – maximum use of limited shore current

The MultiPlus can supply a huge charging current. This implies heavy loading of the shore connection or generator set. Therefore a maximum current can be set. The MultiPlus then takes other power users into account, and only uses 'surplus' current for charging purposes.

PowerAssist – Extended use of your generator and shore current: the MultiPlus “co-supply” feature

This feature takes the principle of PowerControl to a further dimension allowing the MultiPlus to supplement the capacity of the alternative source. Where peak power is so often required only for a limited period, the MultiPlus will make sure that insufficient shore or generator power is immediately compensated for by power from the battery. When the load reduces, the spare power is used to recharge the battery.

This unique feature offers a definitive solution for the ‘shore current problem’: high power electric tools, dish washers, washing machines, electric cooking etc. can all run on 16A shore current, or even less. In addition, a smaller generator can be installed.

Three programmable relays

The relays can be programmed for all kinds of applications, for example as a starter relay for a generating set.

Two programmable analog/digital input/output ports

These ports can be used for several purposes. One application is communication with the BMS of a lithium-ion battery.

Frequency shift

When solar inverters are connected to the output of a Multi or Quattro, the excess solar energy is used to recharge the batteries. Once the absorption voltage is reached, the Multi or Quattro will shut down the solar inverter by shifting the output frequency 1Hz (from 50Hz to 51Hz for example). Once battery voltage has dropped slightly, the frequency returns to normal and the solar inverters will restart.

Built-in Battery Monitor (optional)

The ideal solution when Multis or Quattros are part of a hybrid system (diesel generator, inverter/chargers, storage battery, and alternative energy). The built-in battery monitor can be set to start and stop the generator:

- Start at a preset % discharge level, and/or
- start (with a preset delay) at a preset battery voltage, and/or
- start (with a preset delay) at a preset load level.
- Stop at a preset battery voltage, or
- stop (with a preset delay) after the bulk charge phase has been completed, and/or
- stop (with a preset delay) at a preset load level.

Solar energy

The MultiPlus is extremely suitable for solar energy applications. It can be used in autonomous systems as well as grid connected systems.

Autonomous operation when the grid fails

Houses or buildings with solar panels or a combined micro-scale heating and power plant or other sustainable energy sources have a potential autonomous energy supply which can be used for powering essential equipment (central heating pumps, refrigerators, deep freeze units, Internet connections, etc.) during a power failure. A problem is however that grid connected sustainable energy sources drop out as soon as the grid fails. With a MultiPlus and batteries, this problem can be solved in a simple manner: **the MultiPlus can replace the grid during a power failure**. When the sustainable energy sources produce more power than needed, the MultiPlus will use the surplus to charge the batteries; in the event of a shortfall, the MultiPlus will supply additional power from the battery.

Programmable with DIP switches, VE.Net panel or personal computer

The MultiPlus is supplied ready for use. Three features are available for changing certain settings if desired:

- The most important settings (including parallel operation of up to three devices and 3-phase operation) can be changed in a very simple manner, using DIP switches.
- All settings, with exception of the multi-functional relay, can be changed with a VE.Net panel.
- All settings can be changed with a PC and free of charge software, downloadable from our website www.victronenergy.com

2.2 Battery charger

Adaptive 4-stage charging characteristics: bulk – absorption – float – storage

The microprocessor-driven adaptive battery management system can be adjusted for various types of batteries. The adaptive function automatically adapts the charging process to battery use.

The right amount of charge: variable absorption time

In the event of slight battery discharge, absorption is kept short to prevent overcharging and excessive gas formation. After deep discharging, the absorption time is automatically extended in order to fully charge the battery.

Preventing damage due to excessive gassing: the BatterySafe mode

If, in order to quickly charge a battery, a high charge current in combination with a high absorption voltage has been chosen, damage due to excessive gassing will be prevented by automatically limiting the rate of voltage increase once the gassing voltage has been reached.

Less maintenance and aging when the battery is not in use: the Storage mode

The Storage mode kicks in whenever the battery has not been subjected to discharge during 24 hours. In the Storage mode float voltage is reduced to 2,2V/cell (13,2V for 12V battery) to minimise gassing and corrosion of the positive plates. Once a week the voltage is raised back to the absorption level to 'equalize' the battery. This feature prevents stratification of the electrolyte and sulphation, a major cause of early battery failure.

Two DC outputs for charging two batteries

The main DC terminal can supply the full output current. The second output, intended for charging a starter battery, is limited to 4A and has a slightly lower output voltage.

Increasing service life of the battery: temperature compensation

The temperature sensor (supplied with the product) serves to reduce charging voltage when battery temperature rises. This is particularly important for maintenance-free batteries, which could otherwise dry out by overcharging.

Battery voltage sense: the correct charge voltage

Voltage loss due to cable resistance can be compensated by using the voltage sense facility to measure voltage directly on the DC bus or on the battery terminals.

More on batteries and charging

Our book 'Energy Unlimited' offers further information on batteries and battery charging, and is available free of charge on our website (see www.victronenergy.com → Support & Downloads' → General Technical Information). For more information on adaptive charging, please also refer to the General Technical Information our website.

2.3 Self consumption – solar energy storage systems

For more information see our white paper **Self Consumption or Grid independence with the Victron Energy Storage Hub**. The appropriate software can be downloaded from our website.

When the Multi/Quattro is used in a configuration in which it will feed back energy to the grid it is required to enable grid code compliance by selecting the grid code country setting with the VEConfigure tool.

This way the Multi/Quattro can comply to the local rules.

Once set, a password will be required to disable grid code compliance or change grid code related parameters.

If the local grid code is not supported by the Multi/Quattro an external certified interface device should be used to connect the Multi/Quattro to the grid.

The Multi/Quattro can also be used as a bidirectional inverter operating parallel to the grid, integrated into a customer designed system (PLC or other) that takes care of the control-loop and grid measurement, see http://www.victronenergy.com/live/system_integration:hub4_grid_parallel

Special note for Australian customers: IEC62109.1 certification and CEC approval for off-grid use does NOT imply approval for grid-interactive installations. Additional certification to IEC 62109.2 and AS 4777.2.2015 are required before grid-interactive systems can be implemented. Please check Clean Energy Council website for current approvals.

3. OPERATION

3.1 On/Off/Charger Only Switch

When switched to "on", the product is fully functional. The inverter will come into operation and the LED "inverter on" will light up.

An AC voltage connected to the "AC in" terminal will be switched through to the "AC out" terminal, if within specifications. The inverter will switch off, the "mains on" LED will light up and the charger commences charging. The "bulk", "absorption" or "float" LEDs will light up, depending on the charger mode.

If the voltage at the "AC-in" terminal is rejected, the inverter will switch on.

When the switch is switched to "charger only", only the battery charger of the Multi will operate (if mains voltage is present). In this mode input voltage also is switched through to the "AC out" terminal.

NOTE: When only the charger function is required, ensure that the switch is switched to "charger only". This prevents the inverter from being switched on if the mains voltage is lost, thus preventing your batteries from running flat.

3.2 Remote control

Remote control is possible with a 3-way switch or with a Multi Control panel.

The Multi Control panel has a simple rotary knob with which the maximum current of the AC input can be set: see PowerControl and PowerAssist in Section 2.

3.3 Equalisation and forced absorption

3.3.1 Equalisation

Traction batteries require regular additional charging. In the equalisation mode, the MultiPlus will charge with increased voltage for one hour (1V above the absorption voltage for a 12V battery, 2V for a 24V battery). The charging current is then limited to 1/4 of the set value. **The "bulk" and "absorption" LEDs flash intermittently.**



Equalisation mode supplies a higher charging voltage than most DC consuming devices can cope with. These devices must be disconnected before additional charging takes place.

3.3.2 Forced absorption

Under certain circumstances, it can be desirable to charge the battery for a fixed time at absorption voltage level. In Forced Absorption mode, the MultiPlus will charge at the normal absorption voltage level during the set maximum absorption time. **The "absorption" LED lights.**

3.3.3 Activating equalisation or forced absorption

The MultiPlus can be put into both these states from the remote panel as well as with the front panel switch, provided that all switches (front, remote and panel) are set to "on" and no switches are set to "charger only".

In order to put the MultiPlus in this state, the procedure below should be followed.

If the switch is not in the required position after following this procedure, it can be switched over quickly once. This will not change the charging state.

NOTE: Switching from "on" to "charger only" and back, as described below, must be done quickly. The switch must be toggled such that the intermediate position is 'skipped', as it were. If the switch remains in the "off" position even for a short time, the device may be turned off. In that case, the procedure must be restarted at step 1. A certain degree of familiarisation is required when using the front switch on the Compact in particular. When using the remote panel, this is less critical.

Procedure:

1. Check whether all switches (i.e. front switch, remote switch or remote panel switch if present) are in the "on" position.
2. Activating equalisation or forced absorption is only meaningful if the normal charging cycle is completed (charger is in 'Float').
3. To activate:
 - a. Switch rapidly from "on" to "charger only" and leave the switch in this position for ½ to 2 seconds.
 - b. Switch rapidly back from "charger only" to "on" and leave the switch in this position for ½ to 2 seconds.
 - c. Switch once more rapidly from "on" to "charger only" and leave the switch in this position.
4. On the MultiPlus (and, if connected, on the MultiControl panel) the three LEDs "Bulk", "Absorption" and "Float" will now flash 5 times.
5. Subsequently, the LEDs "Bulk", "Absorption" and "Float" will each light during 2 seconds.
 - a. If the switch is set to "on" while the "Bulk" LED lights, the charger will switch to equalisation.
 - b. If the switch is set to "on" while the "Absorption" LED lights, the charger will switch to forced absorption.
 - c. If the switch is set to "on" after the three LED sequence has finished, the charger will switch to "Float".
 - d. If the switch has not been moved, the MultiPlus will remain in 'charger only' mode and switch to "Float".

3.4 LED Indications

- LED off
- ☀ LED flashes
- LED illuminated

Inverter

Charger		Inverter	
<input type="radio"/> mains on	on	<input checked="" type="radio"/> inverter on	
<input type="radio"/> Bulk	off	<input type="radio"/> overload	
<input type="radio"/> Absorption	charger only	<input type="radio"/> low battery	
<input type="radio"/> Float		<input type="radio"/> temperature	

The inverter is on and supplies power to the load.

Charger		Inverter	
<input type="radio"/> mains on	on	<input checked="" type="radio"/> inverter on	
<input type="radio"/> Bulk	off	☀ overload	
<input type="radio"/> absorption	charger only	<input type="radio"/> low battery	
<input type="radio"/> Float		<input type="radio"/> temperature	

The nominal output of the inverter is exceeded. The "overload" LED flashes

Charger		Inverter	
<input type="radio"/> mains on	on	<input type="radio"/> inverter on	
<input type="radio"/> Bulk	off	<input checked="" type="radio"/> overload	
<input type="radio"/> absorption	charger only	<input type="radio"/> low battery	
<input type="radio"/> Float		<input type="radio"/> temperature	

The inverter is switched off due to overload or short circuit.

Charger		Inverter	
<input type="radio"/> mains on	on	<input checked="" type="radio"/> inverter on	
<input type="radio"/> Bulk	off	<input type="radio"/> overload	
<input type="radio"/> absorption	charger only	☀ low battery	
<input type="radio"/> Float		<input type="radio"/> temperature	

The battery is almost fully exhausted.

Charger		Inverter	
<input type="radio"/> mains on	on	<input type="radio"/> inverter on	
<input type="radio"/> Bulk	off	<input type="radio"/> overload	
<input type="radio"/> absorption	charger only	<input checked="" type="radio"/> low battery	
<input type="radio"/> Float		<input type="radio"/> temperature	

The inverter has switched off due to low battery voltage.

Charger		Inverter	
<input type="radio"/> mains on	on	<input checked="" type="radio"/> inverter on	
<input type="radio"/> Bulk	off	<input type="radio"/> overload	
<input type="radio"/> absorption	charger only	<input type="radio"/> low battery	
<input type="radio"/> Float		☀ temperature	

The internal temperature is reaching a critical level.

Charger		Inverter	
<input type="radio"/> mains on	on	<input type="radio"/> inverter on	
<input type="radio"/> Bulk	 off	<input type="radio"/> overload	
<input type="radio"/> absorption		<input type="radio"/> low battery	
<input type="radio"/> Float	charger only	<input checked="" type="radio"/> temperature	

The inverter has switched off due to the electronics temperature being too high.

Charger		Inverter	
<input type="radio"/> mains on	on	<input checked="" type="radio"/> inverter on	
<input type="radio"/> Bulk	 off	<input checked="" type="radio"/> overload	
<input type="radio"/> absorption		<input checked="" type="radio"/> low battery	
<input type="radio"/> Float	charger only	<input type="radio"/> temperature	

-If the LEDs are flashing alternately, the battery is nearly exhausted and the nominal output is exceeded.
-If "overload" and "low battery" flash simultaneously, the ripple voltage on the battery terminals is too high.

Charger		Inverter	
<input type="radio"/> mains on	on	<input type="radio"/> inverter on	
<input type="radio"/> Bulk	 off	<input checked="" type="radio"/> overload	
<input type="radio"/> absorption		<input checked="" type="radio"/> low battery	
<input type="radio"/> Float	charger only	<input type="radio"/> temperature	

The inverter switched off due to excess ripple voltage on the battery terminals.

Battery Charger

Charger		Inverter	
<input checked="" type="radio"/> mains on	on	<input type="radio"/> inverter on	
<input checked="" type="radio"/> Bulk	 off	<input type="radio"/> overload	
<input type="radio"/> absorption		<input type="radio"/> low battery	
<input type="radio"/> Float	charger only	<input type="radio"/> temperature	

The AC input voltage is switched through and the charger operates in bulk mode.

Charger		Inverter	
<input checked="" type="radio"/> mains on	on	<input type="radio"/> inverter on	
<input checked="" type="radio"/> Bulk	 off	<input type="radio"/> overload	
<input checked="" type="radio"/> absorption		<input type="radio"/> low battery	
<input type="radio"/> Float	charger only	<input type="radio"/> temperature	

The mains voltage is switched through and the charger is on. The set absorption voltage, however, has not yet been reached. (BatterySafe mode)

Charger		Inverter	
<input checked="" type="radio"/> mains on	on	<input type="radio"/> inverter on	
<input type="radio"/> Bulk	 off	<input type="radio"/> overload	
<input checked="" type="radio"/> absorption		<input type="radio"/> low battery	
<input type="radio"/> Float	charger only	<input type="radio"/> temperature	

The mains voltage is switched through and the charger operates in absorption mode.

Charger		Inverter	
<input checked="" type="radio"/> mains on	on	<input type="radio"/> inverter on	
<input type="radio"/> Bulk		<input type="radio"/> overload	
<input type="radio"/> absorption	off	<input type="radio"/> low battery	
<input checked="" type="radio"/> Float	charger only	<input type="radio"/> temperature	

The mains voltage is switched through and the charger operates in float mode.

Charger		Inverter	
<input checked="" type="radio"/> mains on	on	<input type="radio"/> inverter on	
<input checked="" type="radio"/> Bulk		<input type="radio"/> overload	
<input checked="" type="radio"/> absorption	off	<input type="radio"/> low battery	
<input type="radio"/> Float	charger only	<input type="radio"/> temperature	

The mains voltage is switched through and the charger operates in equalize mode.

Special Indications

PowerControl

charger		Inverter	
<input checked="" type="radio"/> mains on	on	<input type="radio"/> inverter on	
<input type="radio"/> bulk		<input type="radio"/> overload	
<input type="radio"/> absorption	off	<input type="radio"/> low battery	
<input type="radio"/> float	charger only	<input type="radio"/> temperature	

The AC input is switched through. The AC output current is equal to the preset maximum input current. The charge current is reduced to 0.

Power Assist

charger		Inverter	
<input checked="" type="radio"/> mains on	on	<input checked="" type="radio"/> inverter on	
<input type="radio"/> bulk		<input type="radio"/> overload	
<input type="radio"/> absorption	off	<input type="radio"/> low battery	
<input type="radio"/> float	charger only	<input type="radio"/> temperature	

The AC input is switched through but the load requires more current than the preset maximum input current. The inverter is switched on to supply the required additional current.

For more error codes see section 7.3

4. Installation



This product may only be installed by a qualified electrical engineer.

4.1 Location

The product must be installed in a dry and well-ventilated area, as close as possible to the batteries. There should be a clear space of at least 10cm around the appliance for cooling.



Excessively high ambient temperature will result in the following:

- Reduced service life.
- Reduced charging current.
- Reduced peak capacity, or shutdown of the inverter.
- Never position the appliance directly above the batteries.

The MultiPlus is suitable for wall mounting. For mounting purposes, a hook and two holes are provided at the back of the casing (see appendix G). The device can be fitted either horizontally or vertically. For optimal cooling, vertical fitting is preferred.



The interior of the product must remain accessible after installation.

Try and keep the distance between the product and the battery to a minimum in order to minimize cable voltage loss.



For safety purposes, this product should be installed in a heat-resistant environment. You should prevent the presence of e.g. chemicals, synthetic components, curtains or other textiles, etc., in the immediate vicinity.

4.2 Connection of battery cables

In order to utilize the full capacity of the product, batteries with sufficient capacity and battery cables with sufficient cross section should be used. See table.

	12/3000/120	24/3000/70	48/3000/35
Recommended battery capacity (Ah)	400–1200	200–700	100–400
Recommended DC fuse	400A	300A	125A
Recommended cross section (mm ²) per + and - connection terminal			
0 – 5m	2x 50mm ²	50mm ²	35mm ²
5 – 10m	2x 70mm ²	2x 50mm ²	2x 35mm ²

* '2x' means two positive and two negative cables.

Remark: Internal resistance is the important factor when working with low capacity batteries. Please consult your supplier or the relevant sections of our book "Energy Unlimited", downloadable from our website.

Procedure

Proceed as follows to connect the battery cables:



Use a torque wrench with insulated box spanner in order to avoid shorting the battery.

Maximum torque: 11 Nm

Avoid shorting the battery cables.

- Undo the four screws at the front of the enclosure and remove the front panel.
- Connect the battery cables: see Appendix A.
- Tighten the nuts well for minimal contact resistance.

4.3 Connection of the AC cabling

The MultiPlus is a safety class I product (supplied with a ground terminal for safety purposes). **Its AC input and/or output terminals and/or grounding point on the outside of the product must be provided with an uninterruptible grounding point for safety purposes.**

The MultiPlus is provided with a ground relay (relay H, see appendix B) that **automatically connects the Neutral output to the chassis if no external AC supply is available.** If an external AC supply is provided, the ground relay H will open before the input safety relay closes. This ensures the correct operation of an earth leakage circuit breaker that is connected to the output.



- In a fixed installation, an uninterruptible grounding can be secured by means of the grounding wire of the AC input. Otherwise the casing must be grounded.
- In a mobile installation (for example, with a shore current plug), interrupting the shore connection will simultaneously disconnect the grounding connection. In that case, the casing must be connected to the chassis (of the vehicle) or to the hull or grounding plate (of the boat).

In case of a boat, direct connection to the shore ground is not recommended because of potential galvanic corrosion. The solution to this is using an isolation transformer.

The terminal blocks can be found on the printed circuit board, see Appendix A. The shore or mains cable must be connected to the Multi with the aid of a three-wire cable.

- **AC-in** (see appendix A)
The AC input cable can be connected to the terminal block "AC-in".
From left to right: "PE" (earth), "N" (neutral) and "L" (phase).
The AC input must be protected by a fuse or magnetic circuit breaker rated at 50A or less, and cable cross-section must be sized accordingly. If the input AC supply is rated at a lower value, the fuse or magnetic circuit breaker should be down sized accordingly.
- **AC-out-1** (see appendix A)
The AC output cable can be connected directly to the terminal block "AC-out".
From left to right: "PE" (earth), "N" (neutral) and "L" (phase).
With its PowerAssist feature the Multi can add up to 3kVA (that is $3000 / 230 = 13A$) to the output during periods of peak power requirement. Together with a maximum input current of 50A this means that the output can supply up to $50 + 13 = 63A$.
An earth leakage circuit breaker and a fuse or circuit breaker rated to support the expected load must be included in series with the output, and cable cross-section must be sized accordingly. The maximum rating of the fuse or circuit breaker is 63A.
- **AC-out-2** (see appendix A)
A second output is available that disconnects its load in the event of battery operation. On these terminals, equipment is connected **that may only operate if AC voltage is available on AC-in**, e.g. an electric boiler or an air conditioner.
The load on AC-out-2 is disconnected immediately when the MultiPlus switches to battery operation. After AC power becomes available on AC-in, the load on AC-out-2 will be reconnected with a delay of approximately 2 minutes. This to allow a genset to stabilise.
AC-out-2 can support loads of up to 25A. An earth leakage circuit breaker and fuse rated at max. 32A must be connected in series with AC-out-2.

Note: Loads connected to AC-out-2 will be taken into account in the PowerControl / PowerAssist current limit setting. Loads directly connected to the AC supply will **not** be included in the PowerControl / PowerAssist current limit setting.

4.4 Optional Connections

A number of optional connections are possible:

4.4.1 Second Battery

The MultiPlus has a connection for charging a starter battery. For connection see Appendix A.

4.4.2 Voltage Sense

For compensating possible cable losses during charging, two sense wires can be connected with which the voltage directly on the battery or on the positive and negative distribution points can be measured. Use wire with a cross-section of 0,75mm². During battery charging, the MultiPlus will compensate the voltage drop over the DC cables up to a maximum of 1 Volt (i.e. 1V over the positive connection and 1V over the negative connection). If the voltage drop threatens to become larger than 1V, the charging current is limited in such a way that the voltage drop remains limited to 1V.

4.4.3 Temperature Sensor

The temperature sensor supplied with the product may be used for temperature-compensated charging (see Appendix A). The sensor is isolated and must be mounted on the batteries minus pole.

4.4.4 Remote Control

The product can be remotely controlled in two ways.

- With an external switch (connection terminal L, see appendix A). Operates only if the switch on the MultiPlus is set to "on".
- With a Multi Control panel (connected to one of the two RJ48 sockets B, see appendix A). Operates only if the switch on the MultiPlus is set to "on".

Only one remote control can be connected, i.e. either a switch or a Multi control panel.

4.4.5. Programmable relays

The relays can be programmed for all kinds of applications, for example as a starter relay for a generating set.

4.4.6 Programmable analog/digital input/output ports

These ports can be used for several purposes. One application is communication with the BMS of a lithium-ion battery.

4.4.7 Auxiliary AC output (AC-out-2)

Besides the usual uninterruptible output, a second output (AC-out-2) is available that disconnects its load in the event of battery operation. Example: an electric boiler or air conditioner that is allowed to operate only if the genset is running or shore power is available.

In case of battery operation, AC-out-2 is switched off immediately. After the AC supply has become available, AC-out-2 is reconnected with a delay of 2 minutes, this to allow a genset to stabilise prior to connecting a heavy load.

4.4.8 Parallel Connection

The MultiPlus can be connected in parallel with several identical devices. To this end, a connection is established between the devices by means of standard RJ45 UTP cables. The **system** (one or more Multis plus optional control panel) will require subsequent configuration (see Section 5).

In the event of connecting MultiPlus units in parallel, the following requirements must be met:

- A maximum of six units connected in parallel.
- Only identical devices may be connected in parallel.
- The DC connection cables to the devices must be of equal length and cross-section.
- If a positive and a negative DC distribution point is used, the cross-section of the connection between the batteries and the DC distribution point must at least equal the sum of the required cross-sections of the connections between the distribution point and the MultiPlus units.
- Place the MultiPlus units close to each other, but allow at least 10cm for ventilation purposes under, above and beside the units.
- UTP cables must be connected directly from one unit to the other (and to the remote panel). Connection/splitter boxes are not permitted.
- A battery-temperature sensor need only be connected to one unit in the system. If the temperature of several batteries is to be measured, you can also connect the sensors of other MultiPlus units in the system (with a maximum of one sensor per MultiPlus). Temperature compensation during battery charging responds to the sensor indicating the highest temperature.
- Voltage sensing must be connected to the master (see Section 5.5.1.4).
- Only one remote control means (panel or switch) can be connected to the **system**.

4.4.9 Three-phase operation

The MultiPlus can also be used in 3-phase configuration. To this end, a connection between the devices is made by means of standard RJ45 UTP cables (the same as for parallel operation). The **system** (Multis plus an optional control panel) will require subsequently configuration (see Section 5).

Pre-requisites: see Section 4.4.8.

5. Configuration



- Settings may only be changed by a qualified electrical engineer.
- Read the instructions thoroughly before implementing changes.
- During setting of the charger, the AC input must be removed.

5.1 Standard settings: ready for use

On delivery, the MultiPlus is set to standard factory values. In general, these settings are suitable for single-unit operation.

Warning: Possibly, the standard battery charging voltage is not suitable for your batteries! Refer to the manufacturer's documentation, or to your battery supplier!

Standard MultiPlus factory settings

Inverter frequency	60Hz
Input frequency range	45 - 65Hz
Input voltage range	94 - 143VAC
Inverter voltage	120VAC
Stand-alone / parallel / 3-phase	stand-alone
AES (Automatic Economy Switch)	off
Ground relay	on
Charger on/off	on
Battery charge curve	four-stage adaptive with BatterySafe mode
Charging current	75% of the maximum charging current
Battery type	Victron Gel Deep Discharge (also suitable for Victron AGM Deep Discharge)
Automatic equalisation charging	off
Absorption voltage	14.4 / 28.8 / 57.6V
Absorption time	up to 8 hours (depending on bulk time)
Float voltage	13.8 / 27.6 / 55.2V
Storage voltage	13.2 / 26.4 / 52.8V (not adjustable)
Repeated absorption time	1 hour
Absorption repeat interval	7 days
Bulk protection	on
AC input current limit	50A (= adjustable current limit for PowerControl and PowerAssist functions)
UPS feature	on
Dynamic current limiter	off
WeakAC	off
BoostFactor	2
Programmable relay	alarm function
Auxiliary output	25A
PowerAssist	on

5.2 Explanation of settings

Settings that are not self-explanatory are described briefly below. For further information, please refer to the help files in the software configuration programs (see Section 5.3).

Inverter frequency

Output frequency if no AC is present at the input.
Adjustability: 50Hz; 60Hz

Input frequency range

Input frequency range accepted by the MultiPlus. The MultiPlus synchronises within this range with the AC input frequency. The output frequency is then equal to the input frequency.
Adjustability: 45 – 65Hz; 45 – 55Hz; 55 – 65Hz

Input voltage range

Voltage range accepted by the MultiPlus. The MultiPlus synchronises within this range with the AC input voltage. The output voltage is then equal to the input voltage.
Adjustability: Lower limit: 94 - 120V
Upper limit: 120 - 143V

Note: the standard lower limit setting of 94V is intended for connection to a weak mains supply, or to a generator with unstable AC output. This setting may result in a system shut down when connected to a 'brushless, self excited, externally voltage regulated, synchronous AC generator' (synchronous AVR generator). Most generators rated at 10kVA or more are synchronous AVR generators. The shut down is initiated when the generator is stopped and revs down while the AVR simultaneously 'tries' to keep the output voltage of the generator at 120V.
The solution is to increase the lower limit setting to 110VAC (the output of AVR generators is generally very stable), or to disconnect the Multi(s) from the generator when a generator stop signal is given (with help of an AC contactor installed in series with the generator).

Inverter voltage

Output voltage of the MultiPlus in battery operation.
Adjustability: 95 – 128V

Stand-alone / parallel operation / 2-3 phase setting

Using several devices, it is possible to:

- increase total inverter power (several devices in parallel)
- create a split-phase system by stacking (only for MultiPlus units with 120V output voltage)
- create a split-phase system with a separate autotransformer: see VE autotransformer datasheet and manual
- create a 3-phase system.

The standard product settings are for standalone operation. For parallel, three phase or split phase operation see sections 5.3 / 5.4 and 5.5.

AES (Automatic Economy Switch)

If this setting is turned 'on', the power consumption in no-load operation and with low loads is decreased by approx. 20%, by slightly 'narrowing' the sinusoidal voltage. Applicable in stand-alone configuration only.

Search Mode

Instead of the AES mode, the **search mode** can also be chosen (with help of VEConfigure only).

If search mode is 'on', the power consumption in no-load operation is decreased by approx. 70%. In this mode the MultiPlus, when operating in inverter mode, is switched off in case of no load or very low load, and switches on every two seconds for a short period. If the output current exceeds a set level, the inverter will continue to operate. If not, the inverter will shut down again.

The Search Mode "shut down" and "remain on" load levels can be set with VEConfigure.

The standard settings are:

Shut down: 40 Watt (linear load)

Turn on: 100 Watt (linear load)

Not adjustable with DIP switches. Applicable in stand-alone configuration only.

Ground relay (see appendix B)

With this relay (H), the neutral conductor of the AC output is grounded to the chassis when the back feed safety relay is open. This ensures the correct operation of earth leakage circuit breakers in the output.

- If a non-grounded output is required during inverter operation, this function must be turned off, see appendix A. Not adjustable with DIP switches.
- Models with 50A transfer capacity only: if required an external ground relay can be connected (for a split-phase system with a separate autotransformer). See appendix A.

Battery charge curve

The standard setting is 'Four-stage adaptive with BatterySafe mode'. See Section 2 for a description.

This is the best charging characteristic. See the help files in the software configuration programs for other features.

'Fixed' mode can be selected with DIP switches.

Battery type

The standard setting is the most suitable for Victron Gel Deep Discharge, Gel Exide A200, and tubular plate stationary batteries (OPzS).

This setting can also be used for many other batteries: e.g. Victron AGM Deep Discharge and other AGM batteries, and many types of flat-plate open batteries. Four charging voltages can be set with DIP switches.

With VEConfigure the charge curve can be adjusted to charge any battery type (Nickel Cadmium batteries, Lithium-ion batteries)

Automatic equalisation charging

This setting is intended for flooded tubular plate traction or OPzS batteries. During absorption the voltage limit increases to 2,83V/cell (34V for a 24V battery) once the charge current has tapered down to less than 10% of the set maximum current.

Not adjustable with DIP switches.

See 'tubular plate traction battery charge curve' in VEConfigure.

Absorption time

The absorption time depends on the bulk time (adaptive charge curve), so that the battery is optimally charged. If the 'fixed' charging characteristic is selected, the absorption time is fixed. For most batteries, a maximum absorption time of eight hours is suitable. If an extra high absorption voltage is selected for rapid charging (only possible for open, flooded batteries!), four hours is preferable. With DIP switches, a time of eight or four hours can be set. For the adaptive charge curve, this determines the maximum absorption time.

Storage voltage, Repeated Absorption Time, Absorption Repeat Interval

See Section 2. Not adjustable with DIP switches.

Bulk Protection

When this setting is 'on', the bulk charging time is limited to 10 hours. A longer charging time could indicate a system error (e.g. a battery cell short-circuit). Not adjustable with DIP switches.

AC input current limit

These are the current limit settings for which PowerControl and PowerAssist come into operation.

PowerAssist setting range:

From 6,3A to 50A.

Factory setting: the maximum value (50A).

See Section 2, the book 'Energy Unlimited', or the many descriptions of the unique PowerAssist feature on our website www.victronenergy.com.

AC input current limit

These are the current limit settings for which PowerControl and PowerAssist come into operation.

PowerAssist setting range:

From 5,3A to 50A for models with 50A transfer capacity

Factory setting: the maximum value (50A).

See Section 2, the book 'Energy Unlimited', or the many descriptions of this unique feature on our website www.victronenergy.com.

UPS feature

If this setting is 'on' and AC on the input fails, the MultiPlus switches to inverter operation practically without interruption. The MultiPlus can therefore be used as an Uninterruptible Power Supply (UPS) for sensitive equipment such as computers or communication systems.

The output voltage of some small generator sets is too unstable and distorted for using this setting – the MultiPlus would continually switch to inverter operation. For this reason, the setting can be turned off. The MultiPlus will then respond less quickly to AC input voltage deviations. The switchover time to inverter operation is consequently slightly longer, but most equipment (most computers, clocks or household equipment) is not adversely impacted.

Recommendation: Turn the UPS feature off if the MultiPlus fails to synchronise, or continually switches back to inverter operation.

Dynamic current limiter

Intended for generators, the AC voltage being generated by means of a static inverter (so-called 'inverter' generators). In these generators, rpm is down-controlled if the load is low: this reduces noise, fuel consumption and pollution. A disadvantage is that the output voltage will drop severely or even completely fail in the event of a sudden load increase. More load can only be supplied after the engine is up to speed.

If this setting is 'on', the MultiPlus will start supplying extra power at a low generator output level and gradually allow the generator to supply more, until the set current limit is reached. This allows the generator engine to get up to speed.

This setting is also often used for 'classical' generators that respond slowly to sudden load variation.

WeakAC

Strong distortion of the input voltage can result in the charger hardly operating or not operating at all. If WeakAC is set, the charger will also accept a strongly distorted voltage, at the cost of greater distortion of the input current.

Recommendation: Turn WeakAC on if the charger is hardly charging or not charging at all (which is quite rare!). Also turn on the dynamic current limiter simultaneously, and reduce the maximum charging current to prevent overloading the generator if necessary.

Note: when WeakAC is on, the maximum charge current is reduced by approximately 20%.

Not adjustable with DIP switches.

BoostFactor

Change this setting only after consulting with Victron Energy or with an engineer trained by Victron Energy!

Not adjustable with DIP switches.

Three programmable relays

The MultiPlus is equipped with 3 programmable relays. The relays can be programmed for all kinds of other applications, for example as a starter relay for a generating set. The default setting of the relay in position I (see appendix A, upper right corner) is 'alarm'.

Not adjustable with DIP switches.

Auxiliary AC output (AC-out-2)

Besides the uninterruptable output, a second output (AC-out-2) is available that disconnects its load in the event of battery operation.

Example: an electric boiler or air conditioner that is allowed to operate only if the genset is running or shore power is available.

In case of battery operation, AC-out-2 is switched off immediately. After the AC supply has become available, AC-out-2 is reconnected with a delay of 2 minutes, this to allow a genset to stabilise prior to connecting a heavy load.



5.3 Configuration by computer

All settings can be changed by means of a computer or with a VE.Net panel (except for the multi-functional relay and the VirtualSwitch when using VE.Net).

The most common settings can be changed by means of DIP switches (see Section 5.5).

NOTE:

This manual is intended for products with firmware xxxx400 or higher (with x any number)

The firmware number can be found on the microprocessor, after removing the front panel.

It is possible to update older units, as long as that same 7 digit number starts with either 26 or 27. When it starts with 19 or 20 you have an old microprocessor and it is not possible to update to 400 or higher.

For changing settings with the computer, the following is required:

- VEConfigure3 software: can be downloaded free of charge at www.victronenergy.com.
- A RJ45 UTP cable and the MK2.2b RS485-to-RS232 interface. If the computer has no RS232 connection, but does have USB, a RS232-to-USB interface cable is needed. Both are available from Victron Energy.

5.3.1 VE.Bus Quick Configure Setup

VE.Bus Quick Configure Setup is a software program with which systems with a maximum of three Multis (parallel or three phase operation) can be configured in a simple manner. VEConfigure3 forms part of this program.

The software can be downloaded free of charge at www.victronenergy.com.

For connection to the computer, a RJ45 UTP cable and the **MK2.2b** RS485-to-RS232 interface is required.

If the computer has no RS232 connection, but does have USB, a **RS232-to-USB interface cable** is needed. Both are available from Victron Energy.

5.3.2 VE.Bus System Configurator

For configuring advanced applications and/or systems with four or more Multis, **VE.Bus System Configurator** software must be used. The software can be downloaded free of charge at www.victronenergy.com. VEConfigure3 forms part of this program.

For connection to the computer, a RJ45 UTP cable and the **MK2.2b** RS485-to-RS232 interface is required.

If the computer has no RS232 connection, but does have USB, a **RS232-to-USB interface cable** is needed. Both are available from Victron Energy.

5.3.3 More software

Several other software tools are available:

- Assitants: to configure Multis and Quattros for particular applications (such as self-consumption applications).
- apps: to help managing and monitoring a system with a smart phone or tablet (see Support → Software on our website, ColorControl panel needed).
- VRM (Victron Remote Monitoring website): numerical and graphical display of system parameters and history (ColorControl panel needed).
- Remote VE Configure: to configure or change settings of a system remotely (ColorControl panel needed).
- The Multi/Quattro can also be used as a bidirectional inverter operating parallel to the grid, integrated into a customer designed system (PLC or other) that takes care of the control-loop and grid measurement, see http://www.victronenergy.com/live/system_integration:hub4_grid_parallel

5.4 Configuration with a VE.Net panel

To this end, a VE.Net panel and the VE.Net to VE.Bus converter is required.

With VE.Net all parameters are accessible, with the exception of the multi-functional relay and the VirtualSwitch.

5.5 Configuration with DIP switches

A number of settings can be changed using DIP switches (see appendix A, position M).

A number of settings can be changed using DIP switches (see appendix A, position M).

Note: When changing settings with DIP switches in a parallel or split-phase/3-phase system one should be aware that not all settings are relevant on all Multis. This because some settings will be dictated by the Master or Leader. Some settings are only relevant in the Master/Leader (ie they are not relevant in a slave or in a follower). Other settings are not relevant for slaves but are relevant for followers.

A note on used terminology:

A system in which more than one Multi is used to create a single AC phase is called a parallel system. In this case one of the Multis will control the whole phase, this one is called the master. The others, called slaves, will just listen to the master to determine their action.

It is also possible to create more AC phases (split-phase or 3-phase) with 2 or 3 Multis. In this case the Multi in phase L1 is called the Leader. The Multis in phase L2 (and L3 if available) will generate the same AC frequency but will follow L1 with a fixed phase shift. These Multis are called followers.

If more Multis are used per phase in a split-phase or 3-phase system (for instance 6 Multis used to build a 3-phase system with 2 Multis per phase) then the Leader of the system is also the Master of phase L1. The Followers in phase L2 and L3 will also take the Master role in phase L2 and L3. All others will be slaves.

Setting up parallel or split-phase/3-phase systems should be done by software, see paragraph 5.3.

TIP: If you don't want to bother about a Multi being a master/slave/follower then the easiest and most straight forward way is to set all settings identically on all Multis.

General procedure:

Turn the Multi on, preferably without load and without AC voltage on the input. The Multi will then operate in inverter mode.

Step 1: Set the DIP switches for:

- the required current limitation of the AC input (not relevant for slaves)
- AES (Automatic Economy Switch) (only relevant in systems with 1 Multi per phase)
- limitation of the charging current (only relevant for Master/Leader)

Press the 'Up' button for 2 seconds (**upper** button to the right of the DIP switches, see appendix A, position K) to store the settings after the required values have been set. You can now re-use the DIP switches to apply the remaining settings (step 2).

Step 2: other settings, set the dipswitches for:

- Charge voltages (only relevant for Master/Leader)
- Absorption time (only relevant for Master/Leader)
- Adaptive charging (only relevant for Master/Leader)
- Dynamic current limiter (not relevant for slaves)
- UPS function (not relevant for slaves)
- converter voltage (not relevant for slaves)
- converter frequency (only relevant for Master/Leader)

Press the 'Down' button for 2 seconds (**lower** button to the right of the DIP switches) to store the settings after the DIP switches have been set in the correct position. You can now leave the DIP switches in the selected positions, so that the 'other settings' can always be recovered.

Remarks:

- The DIP switch functions are described in 'top to bottom' order. Since the uppermost DIP switch has the highest number (8), descriptions start with the switch numbered 8.
- For parallel or 3-phase mode, read the whole setting procedure and make a note of the required DIP switch settings before actually implementing them.

Detailed instruction:

5.5.1 Step 1

5.5.1.1 Current limitation AC input (default: 50A)

If the current demand (Multi load + battery charger) threatens to exceed the set current, the MultiPlus will first reduce its charging current (PowerControl), and subsequently supply additional power from the battery (PowerAssist), if needed.

The AC input current limit can be set to eight different values by means of DIP switches. With a Multi Control Panel, a variable current limit can be set for the AC input.

Procedure

The AC input current limit can be set using DIP switches ds8, ds7 and ds6 (default setting: 50A).

Procedure: set the DIP switches to the required value:

ds8	ds7	ds6	
off	off	off	= 6,3A
off	off	on	= 10A
off	on	off	= 12A
off	on	on	= 16A
on	off	off	= 20A
on	off	on	= 25A
on	on	off	= 30A
on	on	on	= 50A

Remark: Manufacturer-specified continuous power ratings for small generators are sometimes inclined to be rather optimistic. In that case, the current limit should be set to a much lower value than would otherwise be required on the basis of manufacturer-specified data.

5.5.1.2 AES (Automatic Economy Switch)

Procedure: set ds5 to the required value:

ds5	
off	= AES off
on	= AES on

Note: The AES option is only effective if the unit is used 'stand alone'.

5.5.1.3 Battery charge current limitation (default setting 75%)

For maximum battery life, a charge current of 10% to 20% of the capacity in Ah should be applied.

Example: optimal charge current of a 24V/500Ah battery bank: 50A to 100A.

The temperature sensor supplied automatically adjusts the charge voltage to the battery temperature.

If faster charging – and a subsequent higher current – is required:

- The temperature sensor supplied should always be fitted, since fast charging can lead to a considerable temperature rise of the battery bank. The charge voltage will be adapted to the higher temperature (i.e. lowered) by means of the temperature sensor.
- The bulk charge time will sometimes be so short that a fixed absorption time would be more satisfactory ('fixed' absorption time, see ds5, step 2).

Procedure

The battery charge current can be set in four steps, using DIP switches ds4 and ds3 (default setting: 75%).

ds4	ds3	
off	off	= 25%
off	on	= 50%
on	off	= 75%
on	on	= 100%

Note: when WeakAC is on, the maximum charge current is reduced from 100% to approximately 80%.

5.5.1.4 DIP switches ds2 and ds1 are not used during step 1.

IMPORTANT NOTE:

If the last 3 digits of the Multi firmware is in the 100 range (so the firmware number is xxxx1xx (with x any numer)) then ds1 & ds2 are used to set a Multi in stand-alone, parallel or three-phase. Please consult the appropriate manual.

5.5.1.5 Examples

examples of settings:

DS-8 AC input	<input type="checkbox"/> on	DS-8	<input type="checkbox"/> on	DS-8	<input type="checkbox"/> off	DS-8	<input type="checkbox"/> on
DS-7 AC input	<input type="checkbox"/> on	DS-7	<input type="checkbox"/> on	DS-7	<input type="checkbox"/> on	DS-7	<input type="checkbox"/> on
DS-6 AC input	<input type="checkbox"/> on	DS-6	<input type="checkbox"/> on	DS-6	<input type="checkbox"/> on	DS-6	<input type="checkbox"/> off
DS-5 AES	<input type="checkbox"/> off	DS-5	<input type="checkbox"/> off	DS-5	<input type="checkbox"/> off	DS-5	<input type="checkbox"/> on
DS-4 Ch. current	<input type="checkbox"/> on	DS-4	<input type="checkbox"/> on	DS-4	<input type="checkbox"/> on	DS-4	<input type="checkbox"/> off
DS-3 Ch. current	<input type="checkbox"/> off	DS-3	<input type="checkbox"/> on	DS-3	<input type="checkbox"/> on	DS-3	<input type="checkbox"/> on
DS-2 St.-alone mode	<input type="checkbox"/> off	DS-2	<input type="checkbox"/> off	DS-2	<input type="checkbox"/> off	DS-2	<input type="checkbox"/> off
DS-1 St.-alone mode	<input type="checkbox"/> off	DS-1	<input type="checkbox"/> off	DS-1	<input type="checkbox"/> off	DS-1	<input type="checkbox"/> off
Step1, stand-alone Example 1 (factory setting): 8, 7, 6 AC-in: 50A 5 AES: off 4, 3 Charging current: 75% 2, 1 Stand-alone mode		Step1, stand-alone Example 2: 8, 7, 6 AC-in: 50A 5 AES: off 4, 3 Charge: 100% 2, 1 Stand-alone		Step1, stand-alone Example 3: 8, 7, 6 AC-in: 16A 5 AES: off 4, 3 Charge: 100% 2, 1 Stand-alone		Step1, stand-alone Example 4: 8, 7, 6 AC-in: 30A 5 AES: on 4, 3 Charge: 50% 2, 1 Stand-alone	

To store the settings after the required values have been set: press the 'Up' button for 2 seconds (**upper** button to the right of the DIP switches, see appendix A, position J). **The overload and low-battery LEDs will flash to indicate acceptance of the settings.**

We recommend making a note of the settings, and filing this information in a safe place. The DIP switches can now be used to apply the remaining settings (step 2).

5.5.2 Step 2: Other settings

The remaining settings are not relevant (**na**) for slaves.

Some of the remaining settings are not relevant for followers (**L2, L3**). These settings are imposed on the whole system by the leader **L1**. If a setting is irrelevant for **L2, L3** devices, this is mentioned explicitly.

ds8-ds7: Setting charging voltages (**not relevant for L2, L3**)

ds8-ds7	Absorption voltage	Float voltage	Storage voltage	Suitable for
off off	14.1 28.2 56.4	13.8 27.6 55.2	13.2 26.4 52.8	Gel Victron Long Life (OPzV) Gel Exide A600 (OPzV) Gel MK battery
off on	14.4 28.8 57.6	13.8 27.6 55.2	13.2 26.4 52.8	Gel Victron Deep Discharge Gel Exide A200 AGM Victron Deep Discharge Stationary tubular plate (OPzS)
on off	14.7 29.4 58.8	13.8 27.6 55.2	13.2 26.4 52.8	AGM Victron Deep Discharge Tubular plate traction batteries in semi-float mode AGM spiral cell
on on	15.0 30.0 60.0	13.8 27.6 55.2	13.2 26.4 52.8	Tubular plate traction batteries or OPzS batteries in cyclic mode

ds6: absorption time 8 or 4 hours (**na for L2, L3**) on = 8 hours off = 4 hours

ds5: adaptive charging characteristic (**na for L2, L3**) on = active off = inactive (inactive = fixed absorption time)

ds4: dynamic current limiter on = active off = inactive

ds3: UPS function on = active off = inactive

ds2: converter voltage on = 115V off = 120V

ds1: converter frequency (**na for L2, L3**) on = 50Hz off = 60Hz
(the wide input frequency range (45-55Hz) is 'on' by default)

Note:

- If "adaptive charging algorithm" is on, ds6 sets the maximum absorption time to 8 hours or 4 hours.
- If "adaptive charging algorithm" is off, the absorption time is set to 8 hours or 4 hours (fixed) by ds6.

Step 2: Exemplary settings

Example 1 is the factory setting (since factory settings are entered by computer, all DIP switches of a new product are set to 'off' and do not reflect the actual settings in the microprocessor.).

DS-8 Ch. voltage <input type="checkbox"/> off DS-7 Ch. voltage <input type="checkbox"/> on DS-6 Absorpt. time <input type="checkbox"/> on DS-5 Adaptive ch. <input type="checkbox"/> on DS-4 Dyn. Curr. limit <input type="checkbox"/> off DS-3 UPS function: <input type="checkbox"/> on DS-2 Voltage <input type="checkbox"/> on DS-1 Frequency <input type="checkbox"/> on	DS-8 <input type="checkbox"/> off DS-7 <input type="checkbox"/> off DS-6 <input type="checkbox"/> on DS-5 <input type="checkbox"/> on DS-4 <input type="checkbox"/> off DS-3 <input type="checkbox"/> off DS-2 <input type="checkbox"/> on DS-1 <input type="checkbox"/> on	DS-8 <input type="checkbox"/> on DS-7 <input type="checkbox"/> off DS-6 <input type="checkbox"/> on DS-5 <input type="checkbox"/> on DS-4 <input type="checkbox"/> on DS-3 <input type="checkbox"/> off DS-2 <input type="checkbox"/> off DS-1 <input type="checkbox"/> on	DS-8 <input type="checkbox"/> on DS-7 <input type="checkbox"/> on DS-6 <input type="checkbox"/> off DS-5 <input type="checkbox"/> off DS-4 <input type="checkbox"/> off DS-3 <input type="checkbox"/> on DS-2 <input type="checkbox"/> off DS-1 <input type="checkbox"/> off
Step 2 Example 1 (factory setting): 8, 7 GEL 14,4V 6 Absorption time: 8 hours 5 Adaptive charging: on 4 Dynamic current limit: off 3 UPS function: on 2 Voltage: 120V 1 Frequency: 50Hz	Step 2 Example 2: 8, 7 OPzV 14,1V 6 Abs. time: 8 h 5 Adaptive ch.: on 4 Dyn. Curr. limit: off 3 UPS function: off 2 Voltage: 120V 1 Frequency: 50Hz	Step 2 Example 3: 8, 7 AGM 14,7V 6 Abs. time: 8 h 5 Adaptive ch: on 4 Dyn. Curr. limit: on 3 UPS function: off 2 Voltage: 120V 1 Frequency: 50Hz	Step 2 Example 4: 8, 7 Tub.-plate 15V 6 Abs. time: 4 h 5 Fixed abs. time 4 Dyn. Curr. limit: off 3 UPS function: on 2 Voltage: 120V 1 Frequency: 60Hz

To store the settings after the required values have been set: press the 'Down' button for 2 seconds (**lower** button to the right of the DIP switches). **The temperature and low-battery LEDs will flash to indicate acceptance of the settings.**

The DIP switches can be left in the selected positions, so that the 'other settings' can always be recovered.

6. Maintenance

The MultiPlus does not require specific maintenance. It will suffice to check all connections once a year. Avoid moisture and oil/soot/vapours, and keep the device clean.

7. Error indications

With the procedures below, most errors can be quickly identified. If an error cannot be resolved, please refer to your Victron Energy supplier.

7.1 General error indications

Problem	Cause	Solution
No output voltage on AC-out-2.	MultiPlus in inverter mode	
Multi will not switch over to generator or mains operation.	Circuit breaker or fuse in the AC-in input is open as a result of overload.	Remove overload or short circuit on AC-out-1 or AC-out-2, and reset fuse/breaker.
Inverter operation not initiated when switched on.	The battery voltage is excessively high or too low. No voltage on DC connection.	Ensure that the battery voltage is within the correct range.
"Low battery" LED flashes.	The battery voltage is low.	Charge the battery or check the battery connections.
"Low battery" LED lights.	The converter switches off because the battery voltage is too low.	Charge the battery or check the battery connections.
"Overload" LED flashes.	The converter load is higher than the nominal load.	Reduce the load.
"Overload" LED lights.	The converter is switched off due to excessively high load.	Reduce the load.
"Temperature" LED flashes or lights.	The environmental temperature is high, or the load is too high.	Install the converter in cool and well-ventilated environment, or reduce the load.
"Low battery" and "overload" LEDs flash intermittently.	Low battery voltage and excessively high load.	Charge the batteries, disconnect or reduce the load, or install higher capacity batteries. Fit shorter and/or thicker battery cables.
"Low battery" and "overload" LEDs flash simultaneously.	Ripple voltage on the DC connection exceeds 1,5Vrms.	Check the battery cables and battery connections. Check whether battery capacity is sufficiently high, and increase this if necessary.
"Low battery" and "overload" LEDs light.	The inverter is switched off due to an excessively high ripple voltage on the input.	Install batteries with a larger capacity. Fit shorter and/or thicker battery cables, and reset the inverter (switch off, and then on again).



One alarm LED lights and the second flashes.	The inverter is switched off due to alarm activation by the lighted LED. The flashing LED indicates that the inverter was about to switch off due to the related alarm.	Check this table for appropriate measures in regard to this alarm state.
The charger does not operate.	The AC input voltage or frequency is not within the range set.	Ensure that the AC input is between 95 VAC and 140 VAC, and that the frequency is within the range set (default setting 45-65Hz).
	Circuit breaker or fuse in the AC-in input is open as a result of overload.	Remove overload or short circuit on AC-out-1 or AC-out-2, and reset fuse/breaker.
	The battery fuse has blown.	Replace the battery fuse.
	The distortion or the AC input voltage is too large (generally generator supply).	Turn the settings WeakAC and dynamic current limiter on.
The charger does not operate. "Bulk" LED flashes and "Mains on" LED illuminates.	MultiPlus is in "Bulk protection" mode thus, the maximum bulk charging time of 10 hours is exceeded. Such a long charging time could indicate a system error (e.g. a battery cell short-circuit).	Check your batteries. NOTE: You can reset the error mode by switching off and back on the MultiPlus. The standard MultiPlus factory setting of the "Bulk protection" mode is switched on. The "Bulk protection" mode can be switched off with help of VEConfigure only.
The battery is not completely charged.	Charging current excessively high, causing premature absorption phase.	Set the charging current to a level between 0.1 and 0.2 times the battery capacity.
	Poor battery connection.	Check the battery connections.
	The absorption voltage has been set to an incorrect level (too low).	Set the absorption voltage to the correct level.
	The float voltage has been set to an incorrect level (too low).	Set the float voltage to the correct level.
	The available charging time is too short to fully charge the battery. The absorption time is too short. For adaptive charging this can be caused by an extremely high charging current with respect to battery capacity, so that bulk time is insufficient.	Select a longer charging time or higher charging current. Reduce the charging current or select the 'fixed' charging characteristics.
The battery is overcharged.	The absorption voltage is set to an incorrect level (too high).	Set the absorption voltage to the correct level.
	The float voltage is set to an incorrect level (too high).	Set the float voltage to the correct level.
	Poor battery condition.	Replace the battery.
	The battery temperature is too high (due to poor ventilation, excessively high environmental temperature, or excessively high charging current).	Improve ventilation, install batteries in a cooler environment, reduce the charging current, and connect the temperature sensor.
The charging current drops to 0 as soon as the absorption phase initiates.	The battery is over-heated (>50°C)	<ul style="list-style-type: none"> – Install the battery in a cooler environment – Reduce the charging current – Check whether one of the battery cells has an internal short circuit
	Defective battery temperature sensor	Disconnect the temperature sensor plug in the MultiPlus. If charging functions correctly after approximately 1 minute, the temperature sensor should be replaced.

7.2 Special LED indications

(for the normal LED indications, see section 3.4)

Bulk and absorption LEDs flash synchronously (simultaneously).	Voltage sense error. The voltage measured at the voltage sense connection deviates too much (more than 7V) from the voltage on the positive and negative connection of the device. There is probably a connection error. The device will remain in normal operation. NOTE: If the "inverter on" LED flashes in phase opposition, this is a VE.Bus error code (see further on).
Absorption and float LEDs flash synchronously (simultaneously).	The battery temperature as measured has an extremely unlikely value. The sensor is probably defective or has been incorrectly connected. The device will remain in normal operation. NOTE: If the "inverter on" LED flashes in phase opposition, this a VE.Bus error code (see further on).
"Mains on" flashes and there is no output voltage.	The device is in "charger only" operation and mains supply is present. The device rejects the mains supply or is still synchronising.

7.3 VE.Bus LED indications

Equipment included in a VE.Bus system (a parallel or 3-phase arrangement) can provide so-called VE.Bus LED indications. These LED indications can be subdivided into two groups: OK codes and error codes.

7.3.1 VE.Bus OK codes

If the internal status of a device is in order but the device cannot yet be started because one or more other devices in the system indicate an error status, the devices that are in order will indicate an OK code. This facilitates error tracing in a VE.Bus system, since devices not requiring attention are easily identified as such.

Important: OK codes will only be displayed if a device is not in inverter or charging operation!

- A flashing "bulk" LED indicates that the device can perform inverter operation.
- A flashing "float" LED indicates that the device can perform charging operation.

NOTE: In principle, all other LEDs must be off. If this is not the case, the code is not an OK code. However, the following exceptions apply:

- The special LED indications above can occur together with the OK codes.
- The "low battery" LED can function together with the OK code that indicates that the device can charge.

7.3.2 VE.Bus error codes

A VE.Bus system can display various error codes. These codes are displayed with the "inverter on", "bulk", "absorption" and "float" LEDs.

To interpret a VE.Bus error code correctly, the following procedure should be followed:

1. The device should be in error (no AC output).
2. Is the "inverter on" LED flashing? If not, then there is **no** VE.Bus error code.
3. If one or more of the LEDs "bulk", "absorption" or "float" flashes, then this flash must be in phase opposition to the "inverter on" LED, i.e. the flashing LEDs are off if the "inverter on" LED is on, and vice versa. If this is not the case, then there is **no** VE.Bus error code.
4. Check the "bulk" LED, and determine which of the three tables below should be used.
5. Select the correct column and row (depending on the "absorption" and "float" LEDs), and determine the error code.
6. Determine the meaning of the code in the tables below.

All of the conditions below must be met!:

1. The device is in error! (No AC output)
2. Inverter LED flashes (in opposition to any flashing of the Bulk, Absorption or Float LED)
3. At least one of the LEDs Bulk, Absorption and Float is on or flashing

Bulk LED off				Bulk LED flashes				Bulk LED on						
		Absorption LED					Absorption LED					Absorption LED		
		off	flashing	On			off	flashing	on			off	flashing	on
Float LED	off	0	3	6	Float LED	off	9	12	15	Float LED	off	18	21	24
	flashing	1	4	7		flashing	10	13	16		flashing	19	22	25
	on	2	5	8		on	11	14	17		on	20	23	26

Bulk LED Absorption LED Float LED	Code	Meaning:	Cause/solution:
○ ○ ★	1	Device is switched off because one of the other phases in the system has switched off.	Check the failing phase.
○ ★ ○	3	Not all, or more than, the expected devices were found in the system.	The system is not properly configured. Reconfigure the system. Communication cable error. Check the cables and switch all equipment off, and then on again.
○ ★ ★	4	No other device whatsoever detected.	Check the communication cables.
○ ★ ★	5	Overvoltage on AC-out.	Check the AC cables.
○ ★ ★	10	System time synchronisation problem occurred.	Should not occur in correctly installed equipment. Check the communication cables.
★ ★ ★	14	Device cannot transmit data.	Check the communication cables (there may be a short circuit).
★ ★ ★	17	One of the devices has assumed 'master' status because the original master failed.	Check the failing unit. Check the communication cables.
★ ○ ○	18	Overvoltage has occurred.	Check AC cables.
★ ★ ★	22	This device cannot function as 'slave'.	This device is an obsolete and unsuitable model. It should be replaced.
★ ★ ○	24	Switch-over system protection initiated.	Should not occur in correctly installed equipment. Switch all equipment off, and then on again. If the problem recurs, check the installation.
★ ★ ★	25	Firmware incompatibility. The firmware of one the connected devices is not sufficiently up to date to operate in conjunction with this device.	1) Switch all equipment off. 2) Switch the device returning this error message on. 3) Switch on all other devices one by one until the error message reoccurs. 4) Update the firmware in the last device that was switched on.
★ ★ ★	26	Internal error.	Should not occur. Switch all equipment off, and then on again. Contact Victron Energy if the problem persists.

8. Technical specifications

MultiPlus	12/3000/120-50 120V	24/3000/70-50 120V
PowerControl / PowerAssist	Yes	
AC input	Input voltage range: 95-140VAC; Input frequency: 45 – 65Hz; Power factor: 1	
Maximum feed through current (A)	50	
Minimum AC supply current capacity for PowerAssist (A)	5,3	
INVERTER		
Input voltage range (V DC)	9,5 – 17	19 – 33
Output (1)	Output voltage: 120 VAC ± 2% Frequency: 60 Hz ± 0,1%	
Cont. output power at 25°C / 77°F (VA)	3000	3000
Cont. output power at 25°C / 77°F (W)	2400	2400
Cont. output power at 40°C / 104°F (W)	2200	2200
Cont. output power at 65°C / 150°F (W)	1700	3000
Peak power (W)	6000	6000
Maximum efficiency (%)	93	94
Zero-load power (W)	20	20
Zero-load power in AES mode (W)	15	15
Zero-load power in Search mode (W)	8	10
CHARGER		
AC Input	Input voltage range: 95-140VAC Input frequency: 45 – 65Hz Power factor: 1	
Charge voltage 'absorption' (V DC)	14,4	28,8
Charge voltage 'float' (V DC)	13,8	27,6
Storage mode (V DC)	13,2	26,4
Charge current house battery (A) (4)	120	70
Charge current starter battery (A)	4	
Battery temperature sensor	Yes	
GENERAL		
Auxiliary output	Max. 32A Switches off when no external AC source available	
Programmable relay (5)	Yes, 3x	
Protection (2)	a - g	
VE.Bus communication port	For parallel and three phase operation, remote monitoring and system integration	
General purpose comm. port	Yes, 2x	
Common Characteristics	Operating temp.: -40 to +65°C/ -40 - 150°F (fan assisted cooling) Humidity (non condensing) : max 95%	
ENCLOSURE		
Common Characteristics	Material & Colour: aluminium (blue RAL 5012) Protection category: IP 21	
Battery-connection	M8 bolts (2 plus and 2 minus connections)	
120V AC-connections	Screw terminals 13mm ² (6 AWG)	
Weight (kg)	19	
Dimensions (hwxwd in mm)	362 x 258 x 218	
STANDARDS		
Safety	EN 60335-1, EN 60335-2-29	
Emission / Immunity	EN 55014-1, EN 55014-2, EN 61000-3-3	
Automotive Directive	2004/104/EC	

1) Can be adjusted to 50Hz;

2) Protection

- a. Output short circuit
- b. Overload
- c. Battery voltage too high
- d. Battery voltage too low
- e. Temperature too high
- f. 120VAC on inverter output
- g. Input voltage ripple too high

3) Non linear load, crest factor 3:1

4) At 25°C ambient

5) Programmable relay which can be set for general alarm, DC undervoltage or genset start/stop function

APPENDIX A: Overview connections

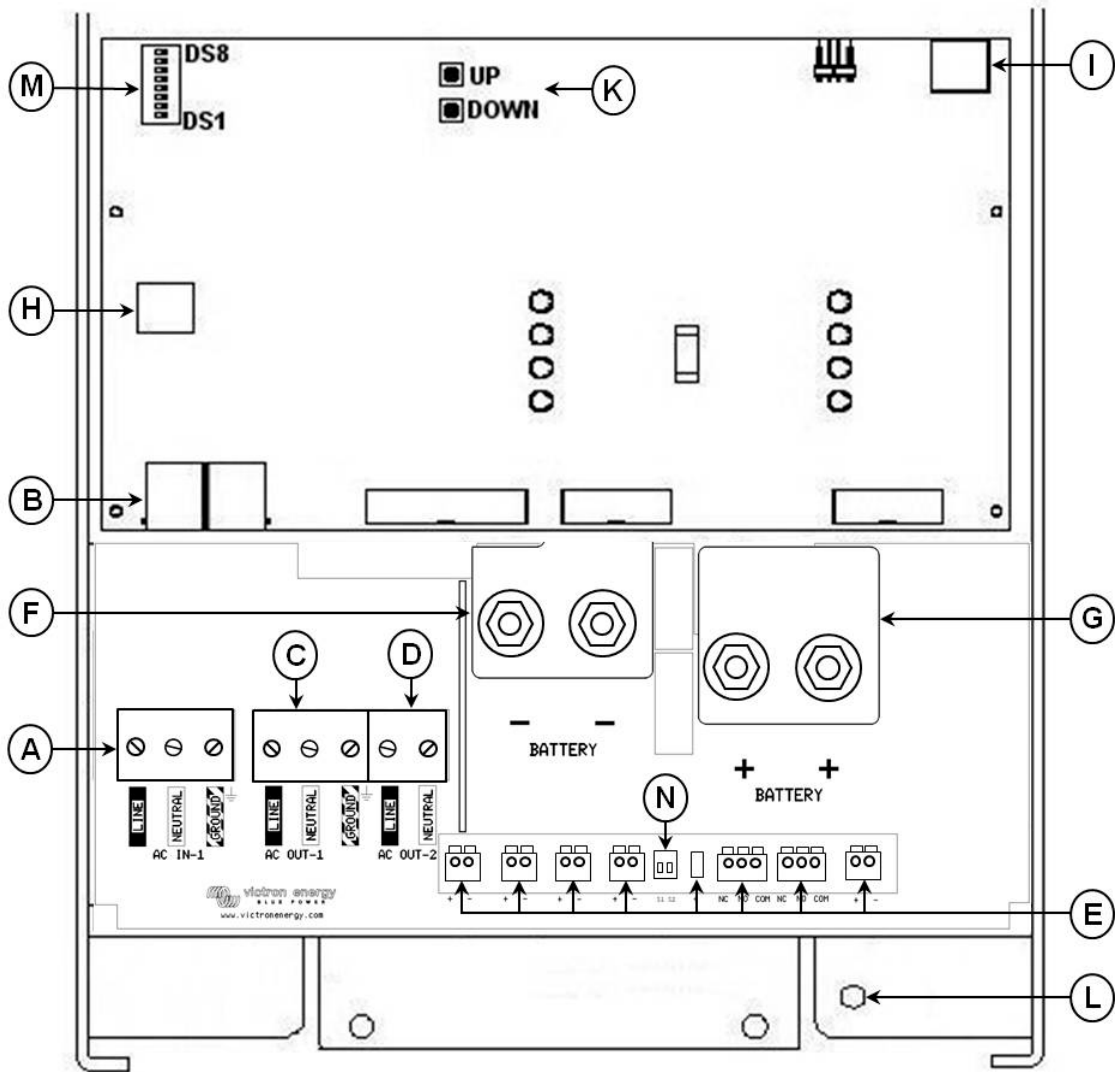

EN:

A	AC input (generator input) AC-in-1. Left to right: GROUND (earth), L (phase), N (neutral).
B	2x RJ45 connector for remote panel and/or parallel and 3-phase operation.
C	AC output AC-out-1. Left to right: L (phase), N (neutral), GROUND (earth).
D	AC output AC-out-2. Left to right: L (phase), N (neutral).
E	Terminals for: (left to right) Temperature sensor plus + & Temperature sensor minus -, Aux input 1 plus + & Aux input 1 minus -, Aux input 2 plus + & Aux input 2 minus -, GND-relay plus + & GND relay minus -, Starter battery plus + (<i>starter battery minus: use battery minus cable for connection</i>), Relay contacts K1 (NC/NO/COM), Relay contacts K2 (NC/NO/COM). Voltage sense plus + & Voltage sense minus -
F	Double M8 battery minus connection.
G	Double M8 battery positive connection.
H	Connector for remote switch: Short left and middle terminal to switch "on". Short right and middle terminal to switch to "charger only".
I	Programmable relay Alarm contact: Left to right: NC, NO, COM.
K	Push buttons for set-up mode
L	Primary ground connection M8 (PE).
M	DIP switches for set-up mode.
N	Slide switches, factory setting SW1= off position, SW2 = off position. SW1: Off = internal GND relay selected, On = external GND relay selected (to connect ext GND relay: see E). SW2: No application. To be used for future features.

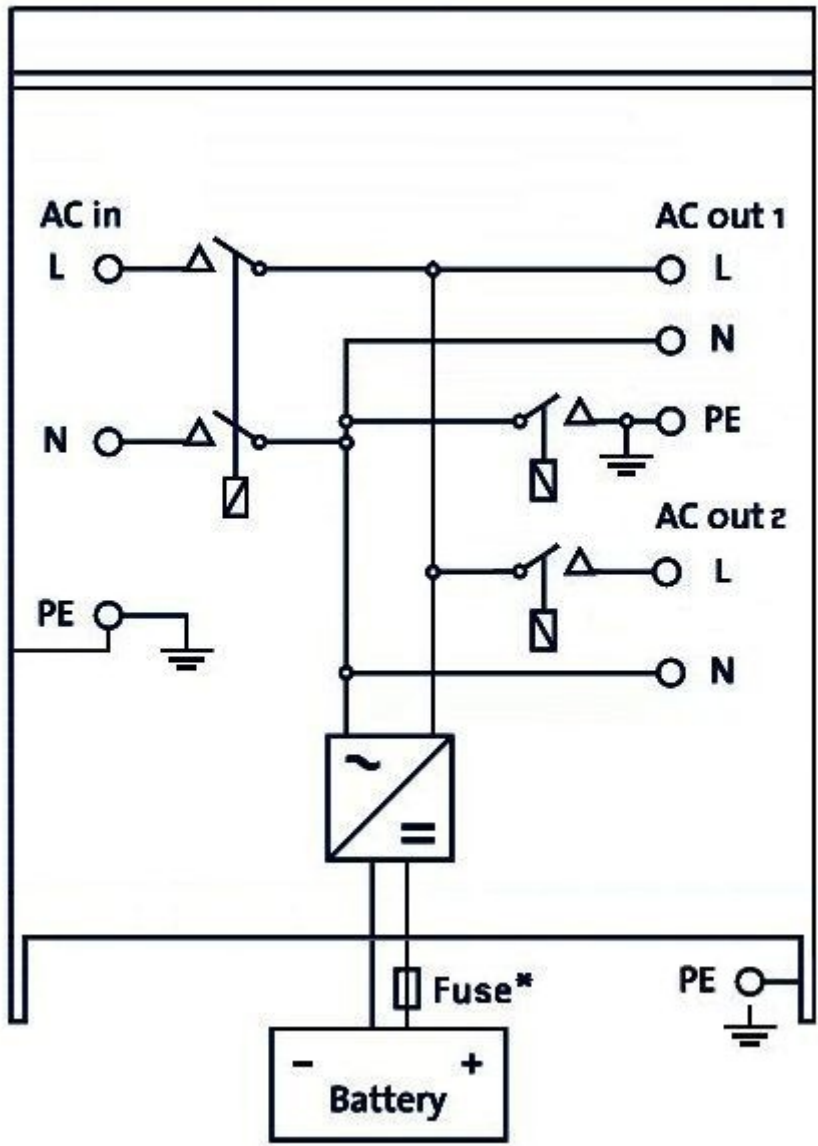

* See table in Chapter 4.2 "Recommended DC fuse".

APPENDIX C: Parallelconnection

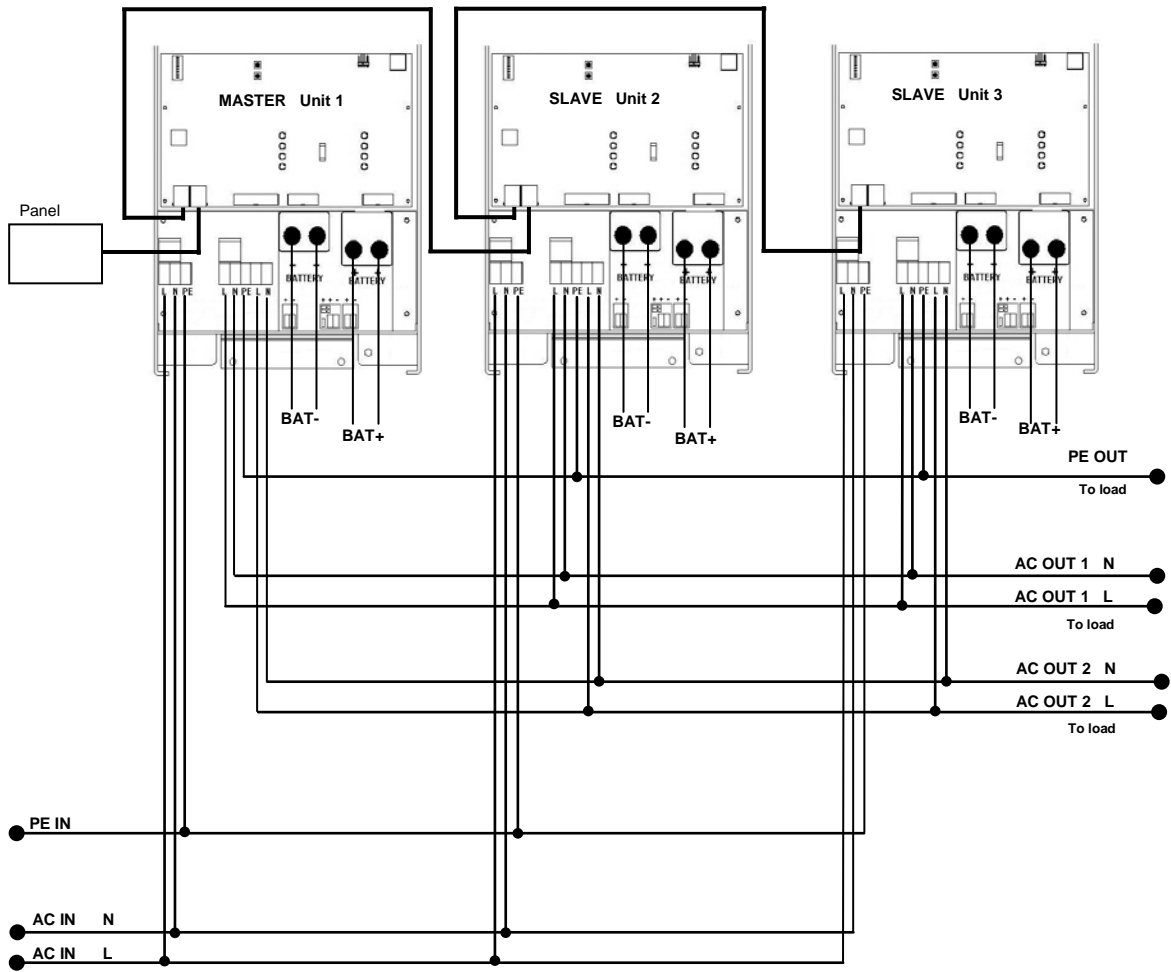

APPENDIX D: Three-phase connection

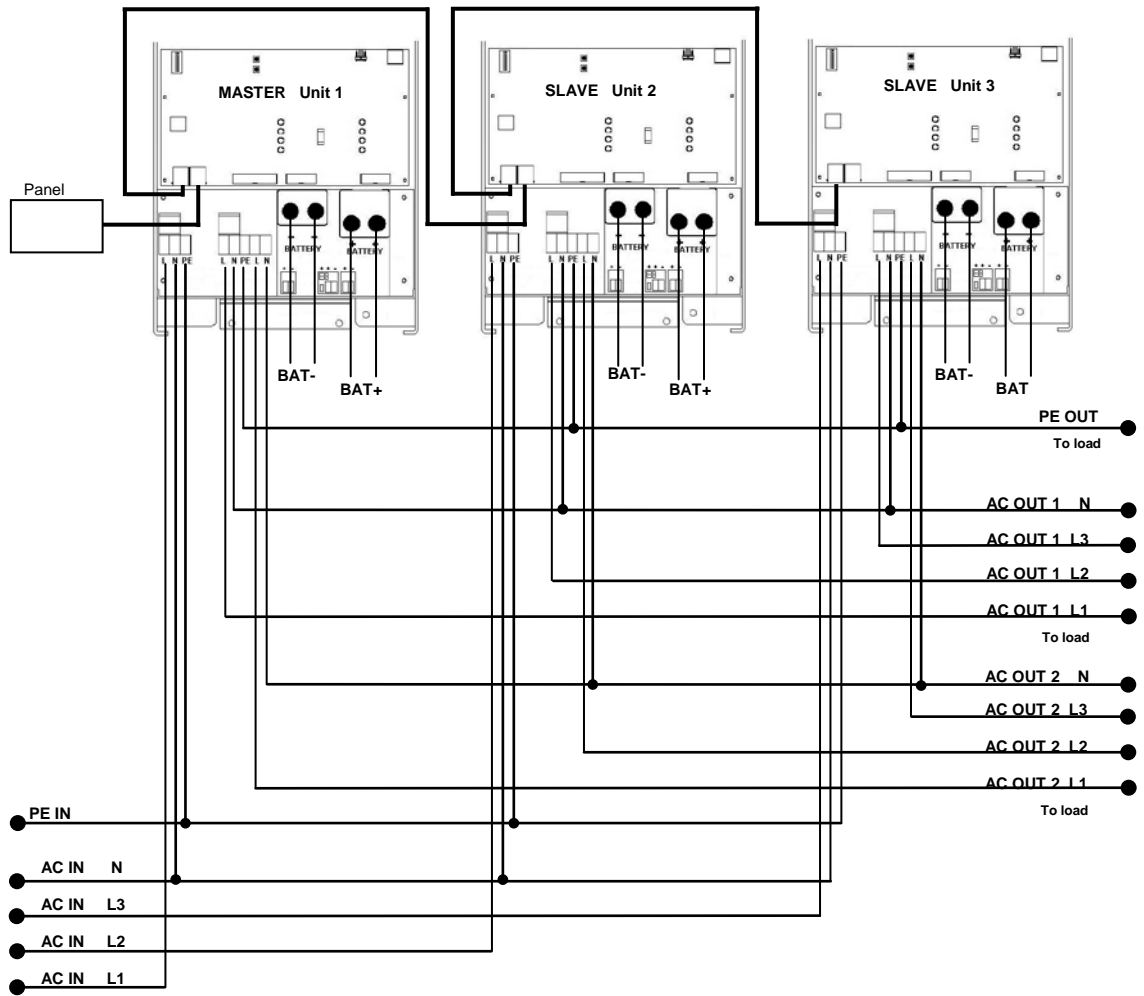

APPENDIX E: Charge characteristic

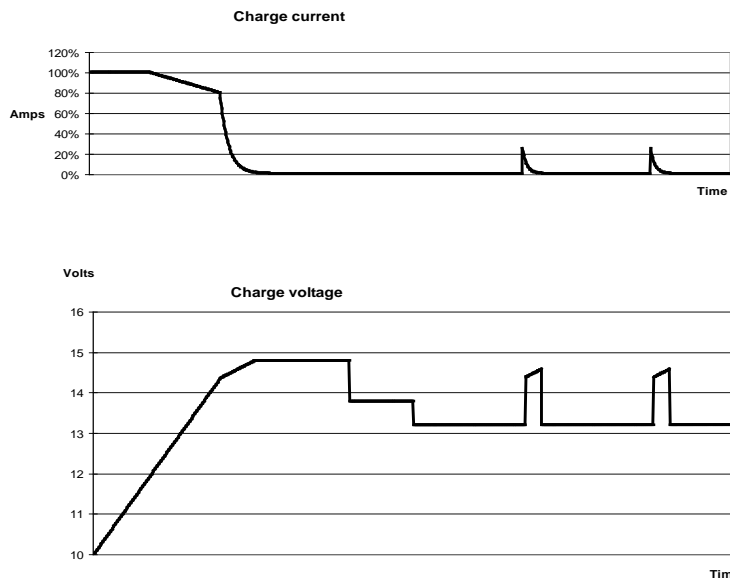

4-stage charging:

Bulk

Entered when charger is started. Constant current is applied until nominal battery voltage is reached, depending on temperature and input voltage, after which constant power is applied up to the point where excessive gassing is starting (14.4V resp. 28.8V, temperature compensated).

Battery Safe

The applied voltage to the battery is raised gradually until the set Absorption voltage is reached. The Battery Safe Mode is part of the calculated absorption time.

Absorption

The absorption period is dependent on the bulk period. The maximum absorption time is the set Maximum Absorption time.

Float

Float voltage is applied to keep the battery fully charged

Storage

After one day of float charge the output voltage is reduced to storage level. This is 13,2V resp. 26,4V (for 12V and 24V charger). This will limit water loss to a minimum when the battery is stored for the winter season.

After an adjustable time (default = 7 days) the charger will enter Repeated Absorption-mode for an adjustable time (default = one hour) to 'refresh' the battery.

APPENDIX F: Temperature compensation

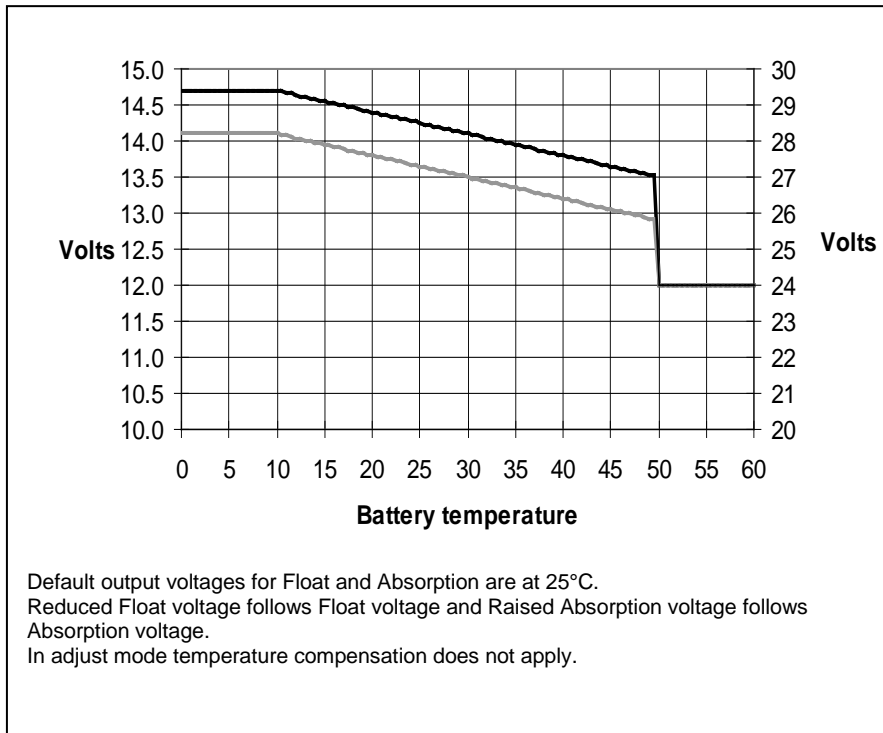

APPENDIX G: Dimensions

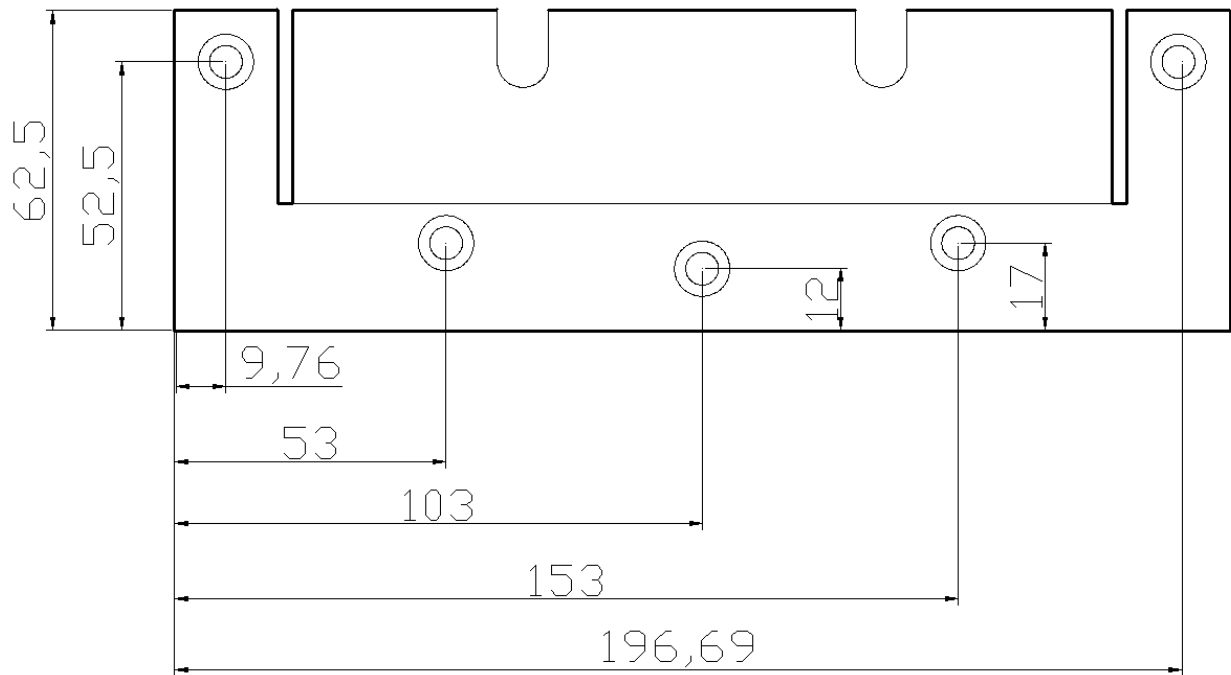

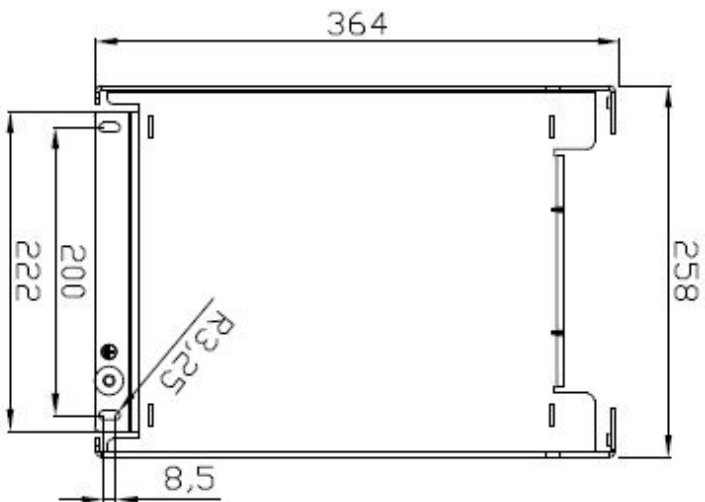
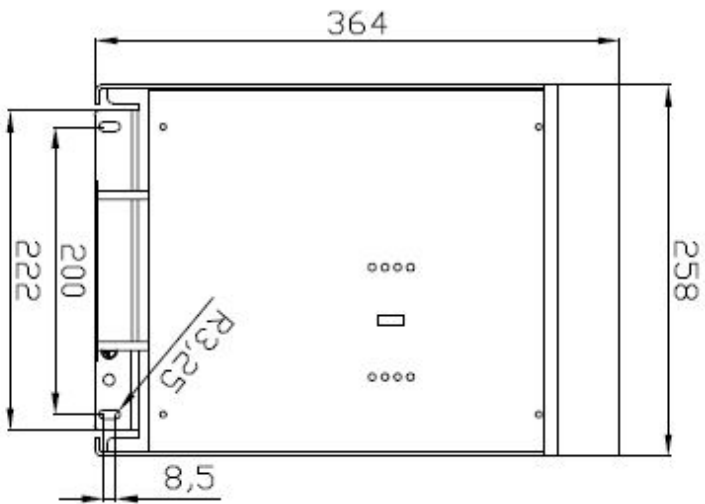
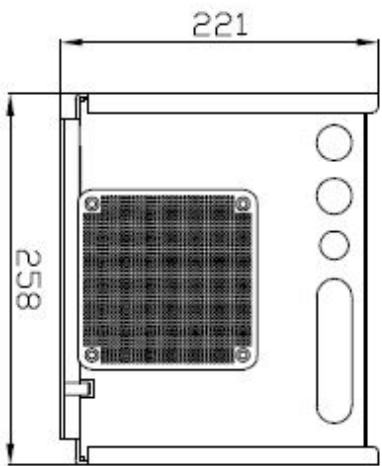
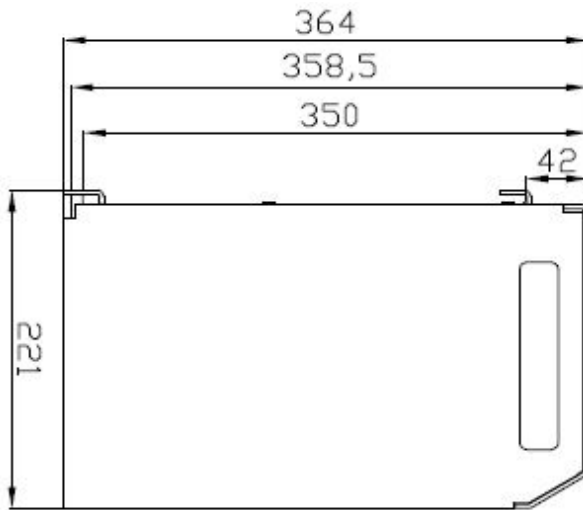

Victron Energy Blue Power

Distributor:

Serial number:

Version : 13a
Date : October 13th, 2016

Victron Energy B.V.
De Paal 35 | 1351 JG Almere
PO Box 50016 | 1305 AA Almere | The Netherlands

General phone : +31 (0)36 535 97 00
Fax : +31 (0)36 535 97 40
E-mail : sales@victronenergy.com

www.victronenergy.com