



Installer's Guide

GTX12V315A-E2107-CS200RV INSTALLATION KIT

VICTRON 3000 WATT

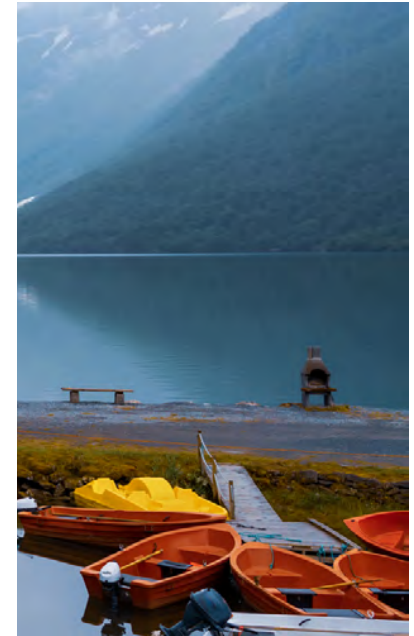
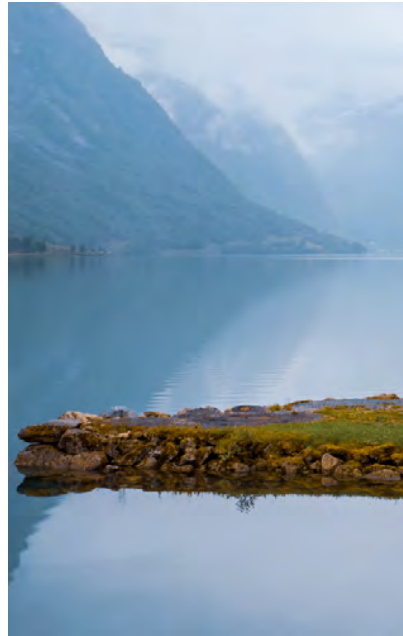
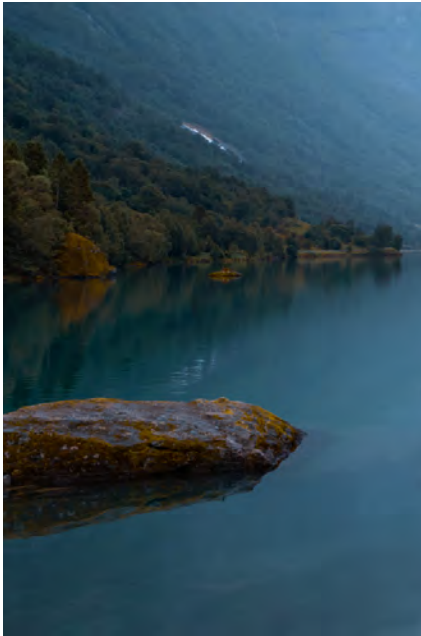

Table of Contents

SAFETY INFORMATION.....	1
INTRODUCTION.....	2
WIRING DIAGRAMS.....	3
MAIN DIAGRAM.....	4
INVERTER DIAGRAM.....	7
STERLING DIAGRAM.....	10
SOLAR DIAGRAM.....	12
BATTERY/IONGAGE DIAGRAM.....	14
PARTS LIST.....	16
BATTERY INSTALLATION.....	17
EQUIPMENT MANUALS.....	20





Safety Information

This manual is intended to be used by qualified installers. Although it is quite detailed, it is meant only as an overall guide to the installation and not to replace the manuals supplied by the relevant equipment manufacturers.

All electrical work should be performed in accordance with local and national electrical codes. Assume that voltage is present at the battery terminals; use insulated tools and gloves while working on the system. Always turn off equipment connected to the battery in addition to turning OFF the Power switch on the battery to isolate it from other electrical circuits before performing any repairs or maintenance on the system.

Always use proper wire sizes to connect the system to inverters, chargers or other equipment. Always use crimped connections to connect to the battery terminals.

Read and follow the inverter, charger or other equipment manufacturer's safety precautions prior to connecting the battery to that equipment. Always use charging equipment compatible with Lithium Iron Phosphate battery chemistry.

Links to the installation manuals relevant to this kit are listed at the back of this manual.

Introduction

The Lithionics **GTX12V315A-E2107-CS200 Victron** kit is based on two **GTX12V315A-E2107-CS200** batteries (630 amp hours) and a **Victron MultiPlus 3000 watt** inverter. This combination is capable of providing enough power to run your AC loads for extended periods of time. The inverter features true sine wave grid quality power, adaptive charging, Power Assist, and many system integration features.

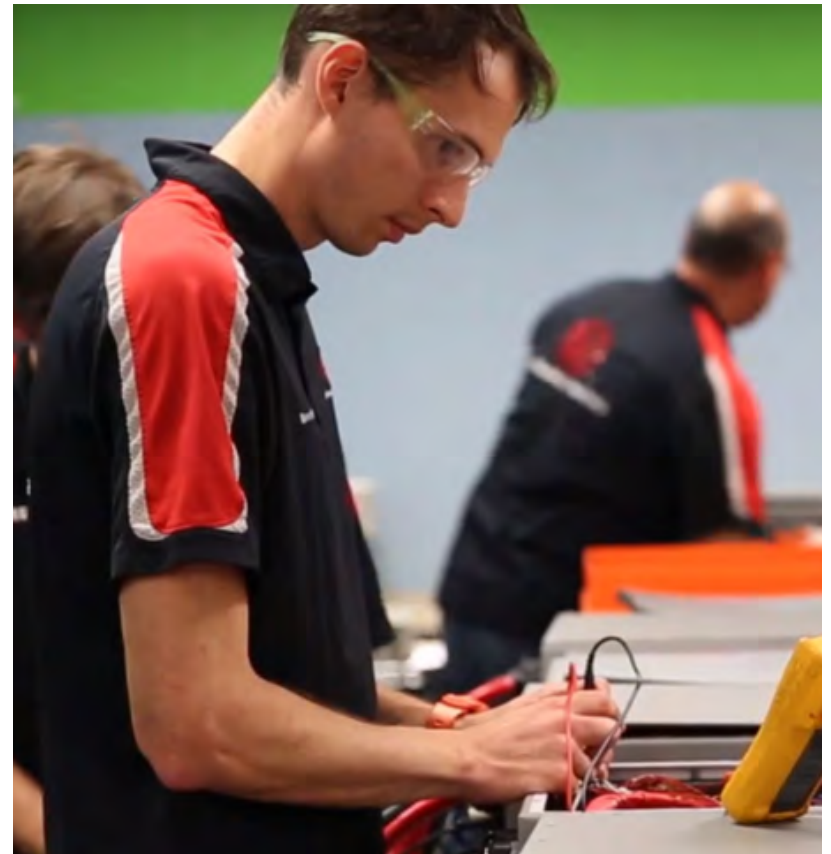

Wiring Diagrams

Main Diagram

Inverter Diagram

Sterling Diagram

Solar Diagram

Battery/IonGage Diagram



Main Diagram

The main diagram depicts the general layout of the system. The 2/0 main battery positive cables are connected to the main distribution buss via two 300A marine rated battery terminal fuses and an isolation switch.

The inverter is connected to the positive distribution buss via two class T 200A fuses and an isolation switch. The fuse blocks and isolation switch should be mounted as close as possible to the positive distribution buss. The isolation switch allows you to isolate the inverter in case of a malfunction as well as disabling the inverter if you need to work on the AC system. The chassis DC grounding conductor (green) should be sized not less than one size smaller than the DC positive conductor and have a capacity such that the DC positive fuse has an amperage rating not greater than 135% of the current rating of this ground wire.

If the positive cable supplying the inverter shorts to ground internally, then the chassis ground cable needs to be able to carry enough current to blow the fuse without melting and possibly causing a fire.

Main Diagram

The inverter is controlled by the **Digital Multi Control Panel**. The front mounted switch is used to turn the system on, off or to charger only operation. The shore current limit is set by the control knob. Turning the knob to the right or left sets the desired value. The current limit is shown on the 7-segment display.

The **Lithionics IonGage** monitors battery voltage, current, power, amp-hours consumed and state of charge.

The **Victron Smart Solar** MPPT charger is connected to the positive distribution buss via a 40A Maxi fuse. The PV solar array is connected to the MPPT charger via a circuit breaker. The specified circuit breaker is only rated at 48VDC; if your PV solar array has an open circuit voltage that is higher, then another circuit breaker with a higher voltage rating must be substituted. The fuse and wire sizes are based on the **Victron Smart Solar** MPPT 100/30 charge controller, if a larger controller is used then the fuse and wire sizes should be increased as required.

The **Sterling battery to battery charger** is connected to the positive distribution buss via a 50A Maxi fuse (80A for the Sterling BB1260 charger). It also has a fuse at the starter battery, this fuse must be installed as close to the battery as possible.

MAIN DIAGRAM

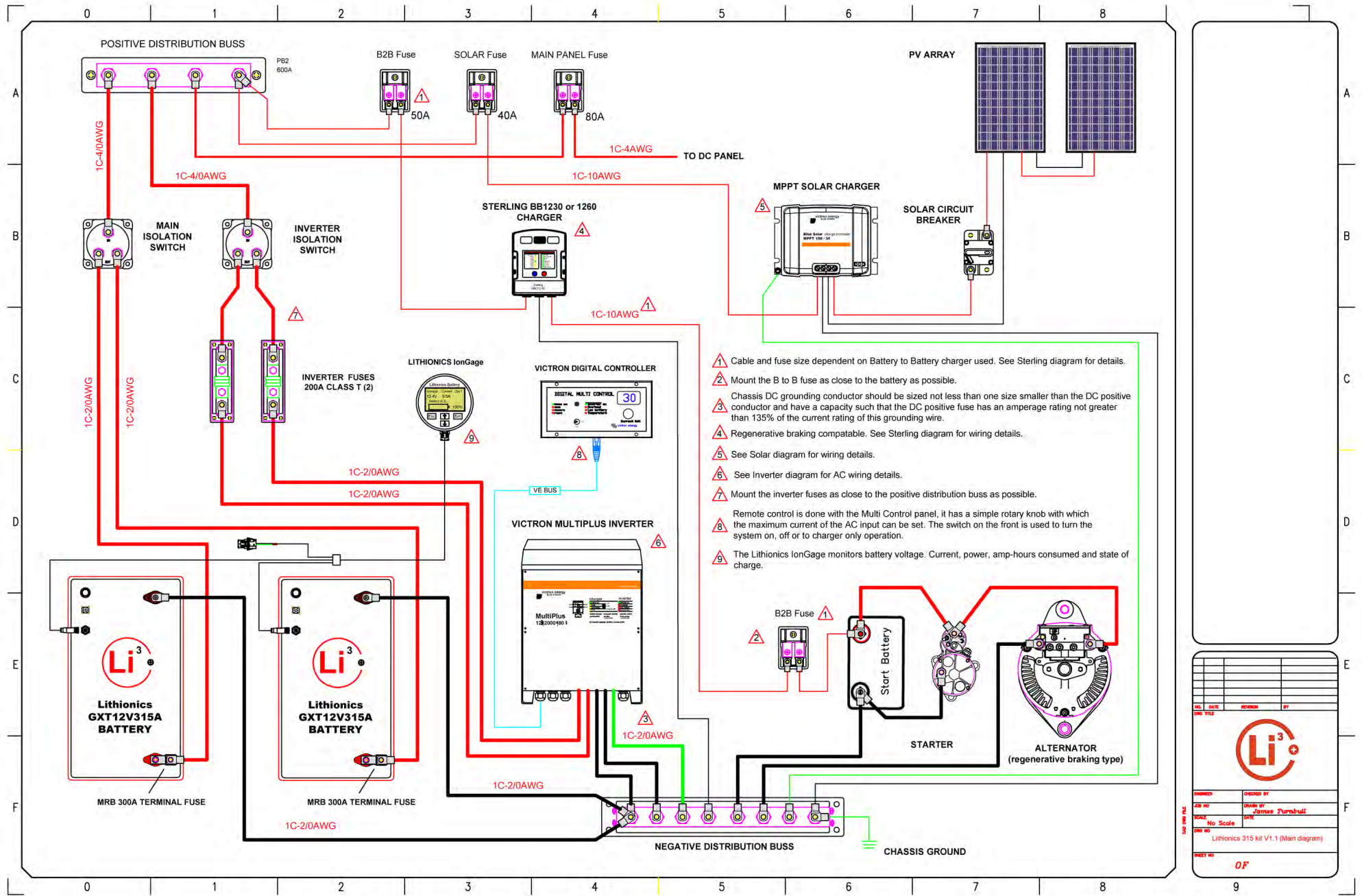

- ⚠️ Cable and fuse size dependent on Battery to Battery charger used. See Sterling diagram for details.
- ⚠️ Mount the B to B fuse as close to the battery as possible.
- ⚠️ Chassis DC grounding conductor should be sized not less than one size smaller than the DC positive conductor and have a capacity such that the DC positive fuse has an amperage rating not greater than 135% of the current rating of this grounding wire.
- ⚠️ Regenerative braking compatible. See Sterling diagram for wiring details.
- ⚠️ See Solar diagram for wiring details.
- ⚠️ See Inverter diagram for AC wiring details.
- ⚠️ Mount the inverter fuses as close to the positive distribution bus as possible.
- ⚠️ Remote control is done with the Multi Control panel, it has a simple rotary knob with which the maximum current of the AC input can be set. The switch on the front is used to turn the system on, off or to charger only operation.
- ⚠️ The Lithionics IonGage monitors battery voltage. Current, power, amp-hours consumed and state of charge.

DATE	REVISION	BY
Li³		
DESIGN	DESIGN BY	
PB NO	SCALE BY	James Furnball
SCALE	DATE	
Lithionics 315 kit V1.1 (Main diagram)		
DF		



Inverter Diagram

The inverter diagram depicts a typical AC installation. The main panel has an output breaker for the non-inverter loads. It is used to power the high power loads that are beyond the inverters capacity such as a water heater or an electric stove. The AC input must be protected a magnetic circuit breaker rated at 50A or less, and the cable cross-section must be sized accordingly. Make all connections using proper crimp-on connectors (do not use twist on connectors).

The inverter has a power assist feature and when enabled can add up to 2kVA (2000 / 120 = 17A) to the output during periods of peak power requirement. Together with a maximum input current of 50A this means that the output can supply up to 67A (50+17).

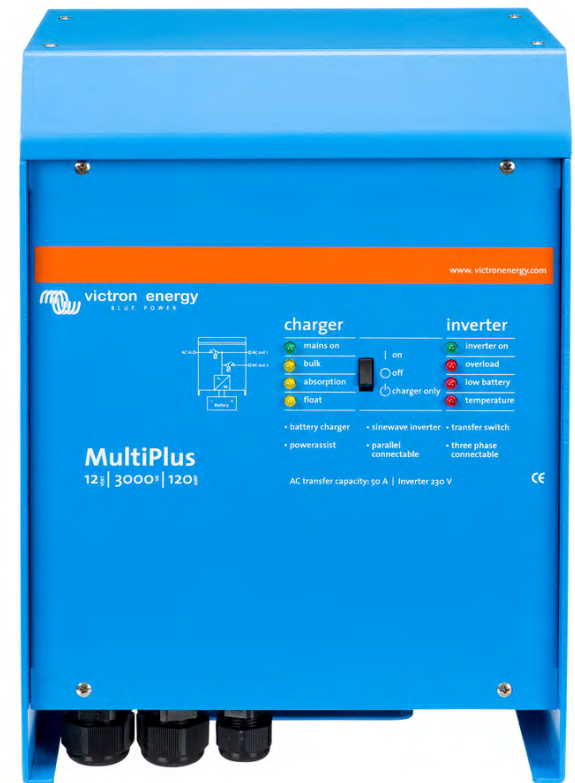

Inverter Diagram

An RCD (Residual Current Device) type circuit breaker rated to support the expected load must be included in series with the output, and cable cross-section must be sized accordingly. This breaker should be as close to the inverter as possible. If this breaker is not of the RCD (Residual Current Device) type, GFCI receptacles must be used at all AC outlets.

The inverter is provided with a ground relay that automatically connects the neutral output to the chassis if no external AC supply is available. In an RV installation, the inverter chassis must be connected the vehicle chassis ground (via the negative distribution buss). The chassis grounding conductor must be not less than one size smaller than the DC positive conductor and have a capacity such that the DC positive fuse has an amperage rating not greater than 135% of the current rating of this grounding wire. **When using an inverter sub panel, the inverter neutrals must return to the inverter sub panel and not the main AC panel.**

A warning label should be installed at the main AC panel to indicate that there is an inverter in the system.



INVERTER DIAGRAM

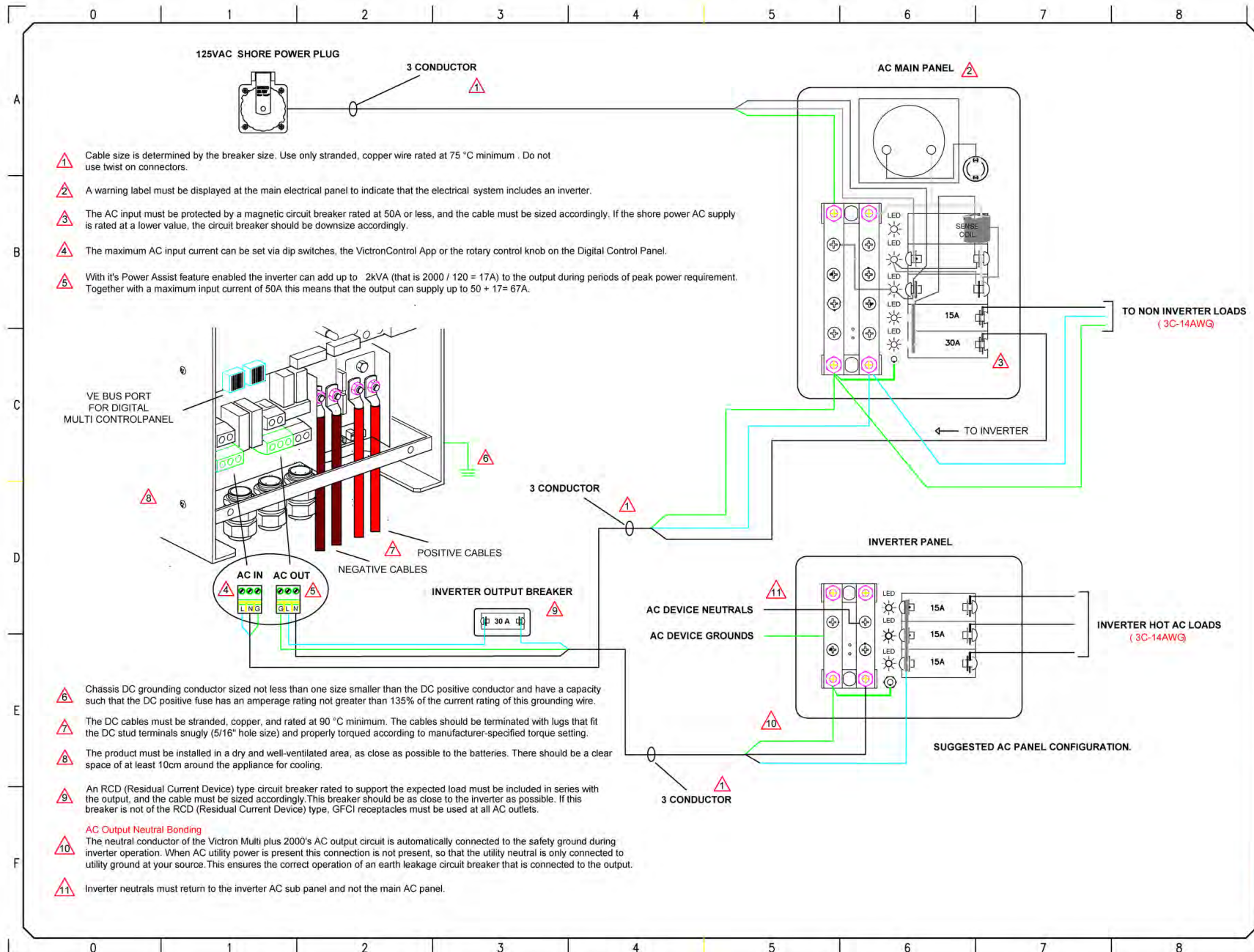

- ⚠ 1 Cable size is determined by the breaker size. Use only stranded, copper wire rated at 75 °C minimum. Do not use twist on connectors.
- ⚠ 2 A warning label must be displayed at the main electrical panel to indicate that the electrical system includes an inverter.
- ⚠ 3 The AC input must be protected by a magnetic circuit breaker rated at 50A or less, and the cable must be sized accordingly. If the shore power AC supply is rated at a lower value, the circuit breaker should be downsize accordingly.
- ⚠ 4 The maximum AC input current can be set via dip switches, the VictronControl App or the rotary control knob on the Digital Control Panel.
- ⚠ 5 With it's Power Assist feature enabled the inverter can add up to 2kVA (that is 2000 / 120 = 17A) to the output during periods of peak power requirement. Together with a maximum input current of 50A this means that the output can supply up to 50 + 17= 67A.

- ⚠ 6 Chassis DC grounding conductor sized not less than one size smaller than the DC positive conductor and have a capacity such that the DC positive fuse has an amperage rating not greater than 135% of this grounding wire.
- ⚠ 7 The DC cables must be stranded, copper, and rated at 90 °C minimum. The cables should be terminated with lugs that fit the DC stud terminals snugly (5/16" hole size) and properly torqued according to manufacturer-specified torque setting.
- ⚠ 8 The product must be installed in a dry and well-ventilated area, as close as possible to the batteries. There should be a clear space of at least 10cm around the appliance for cooling.
- ⚠ 9 An RCD (Residual Current Device) type circuit breaker rated to support the expected load must be included in series with the output, and the cable must be sized accordingly. This breaker should be as close to the inverter as possible. If this breaker is not of the RCD (Residual Current Device) type, GFCI receptacles must be used at all AC outlets.
- ⚠ 10 **AC Output Neutral Bonding**
The neutral conductor of the Victron Multi plus 2000's AC output circuit is automatically connected to the safety ground during inverter operation. When AC utility power is present this connection is not present, so that the utility neutral is only connected to utility ground at your source. This ensures the correct operation of an earth leakage circuit breaker that is connected to the output.
- ⚠ 11 Inverter neutrals must return to the inverter AC sub panel and not the main AC panel.

REV	DATE	REVISION	BY
DESIGNED BY	DESIGNED BY James Furness		
DRAWN BY	DATE		
SCALE	No Scale		
REV NO	Lithionics 315 kit V1.1 (inverter diagram)		
HEET NO	OF		

Sterling Diagram

The **Sterling Battery to Battery charger** charges the house battery via the vehicle's alternator. This system uses either the Sterling BB1230 charger (Mercedes recommendation), or the BB1260 charger depending on the size of the alternator. The charger should be programmed to charge the battery using a Lithium battery profile. The charger can also be configured to work with vehicles using regenerative braking.



Sterling Power Battery to Battery Charger 12V input to 12V output up to 60amps.



Sterling Power Battery to Battery Charger 12V input to 12V output 30amps

STERLING DIAGRAM

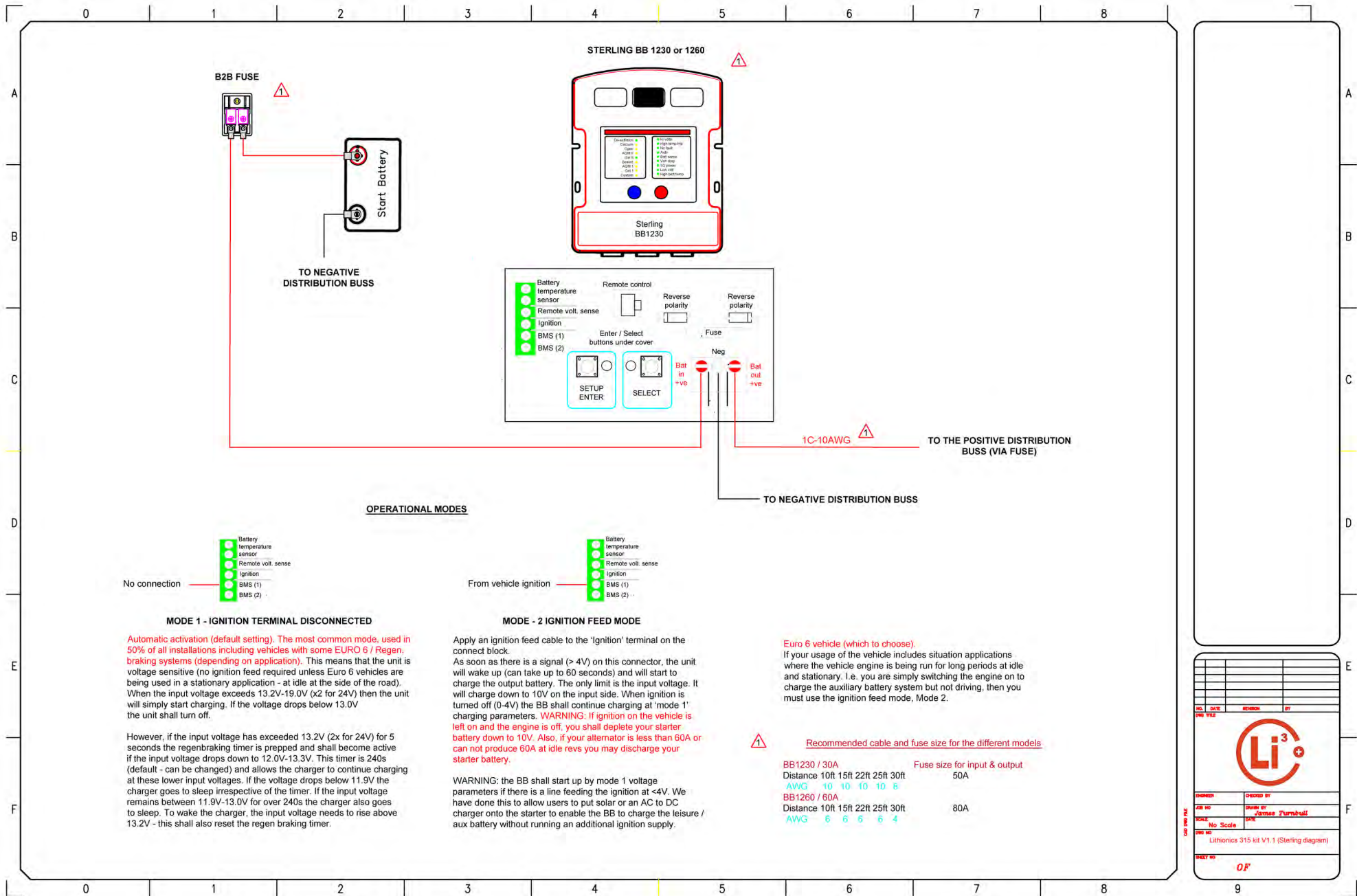

DATE	REVISED	BY

DESIGNED BY	DESIGNED BY
SCALE	SCALE BY
DATE NO	DATE
Lithionics 315 kit V1.1 (Sterling diagram)	
OF	



Solar Diagram

The **Victron Smart Solar** MPPT solar charge controller uses maximum power point tracking that optimizes the match between the solar array and the battery bank. It converts the higher voltage DC output from the solar panels down to the lower voltage needed to charge the batteries. The PV solar array is connected to the MPPT charger with a circuit breaker (not supplied). The specified circuit breaker is only rated at 48VDC; if your PV solar array has an open circuit voltage that is higher, then another circuit breaker with a higher voltage rating must be substituted.

The charger is connected to the positive distribution buss via a 40A fuse. The fuse and wire sizes are based on the **Victron MPPT 100/30** charge controller, if a larger controller is used then the fuse and wire sizes should be increased as required.

Using the **VictronConnect** App on your smartphone you can connect via blue tooth and remotely control and monitor the **Smart Solar MPPT** charger.



SOLAR DIAGRAM

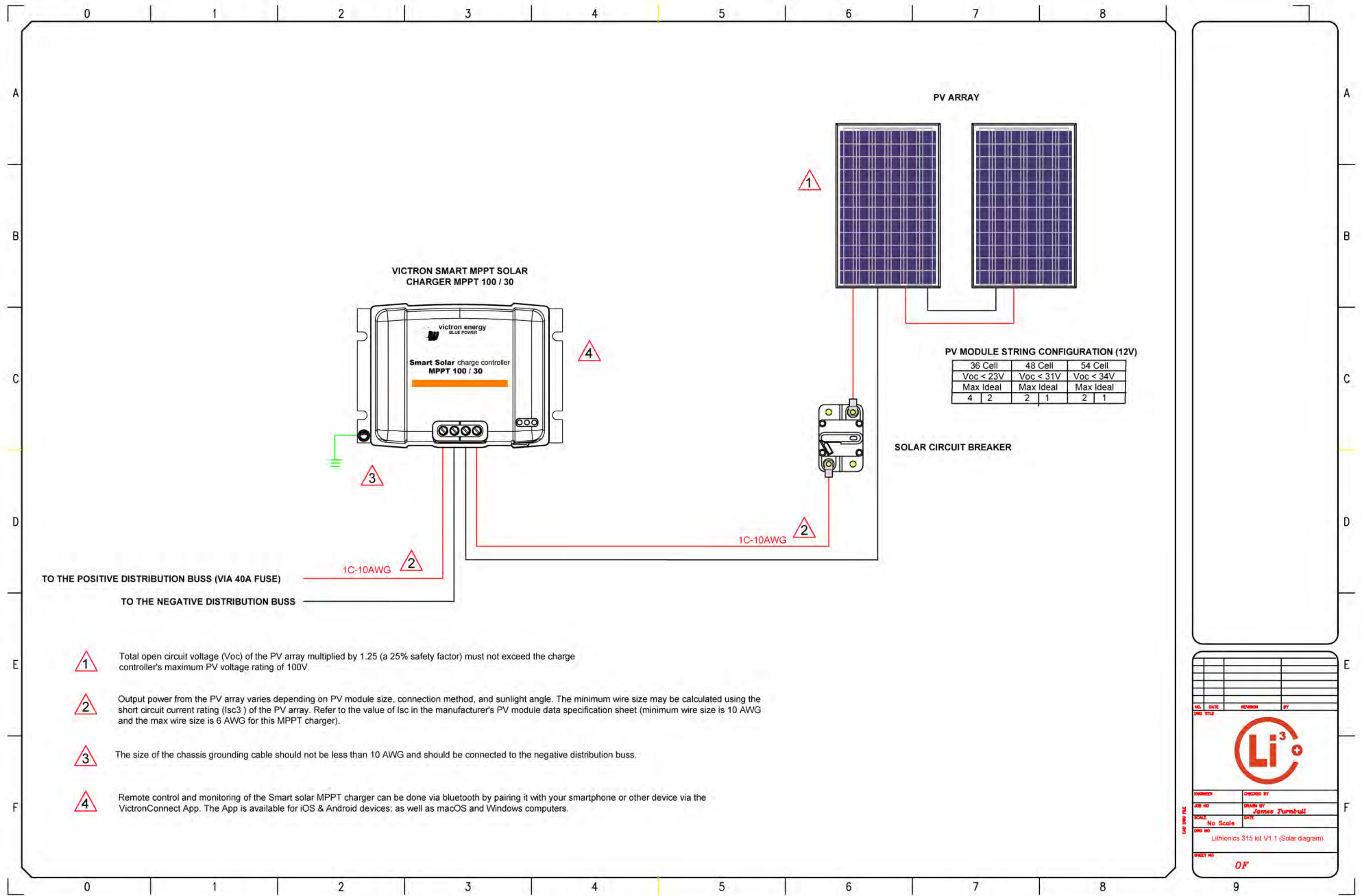

- 1** Total open circuit voltage (Voc) of the PV array multiplied by 1.25 (a 25% safety factor) must not exceed the charge controller's maximum PV voltage rating of 100V.
- 2** Output power from the PV array varies depending on PV module size, connection method, and sunlight angle. The minimum wire size may be calculated using the short circuit current rating (Isc) of the PV array. Refer to the value of Isc in the manufacturer's PV module data specification sheet (minimum wire size is 10 AWG and the max wire size is 6 AWG for this MPPT charger).
- 3** The size of the chassis grounding cable should not be less than 10 AWG and should be connected to the negative distribution buss.
- 4** Remote control and monitoring of the Smart solar MPPT charger can be done via bluetooth by pairing it with your smartphone or other device via the VictronConnect App. The App is available for iOS & Android devices; as well as macOS and Windows computers.

Battery/IonGage Diagram

The Advanced Series BMS includes an integrated SOC Gauge, designed to track battery state of charge (percent of usable energy left in the battery) as well as other useful data parameters. Tracking state of charge is accomplished by a Coulomb counter, based on an internal, high sensitivity hall-effect sensor. The SOC Gauge data will only be correct if the configuration parameters are set correctly, which are pre-set initially by Lithionics Battery, but are user adjustable with supporting hardware. The SOC Gauge will also track and display live amperage (A), live wattage (W), battery voltage (V), temperature (F/C), amp hours (Ah), watt hours (Wh), time remaining (d/h), etc. The meter will be most accurate if the battery is fully charged on a regular basis. If the battery is always partially charged, then the SOC meter reading may drift in the long term and will become less accurate. When the most accurate measurements are required it is recommended to perform a full charge at least weekly.



BATTERY/IONGAGE DIAGRAM

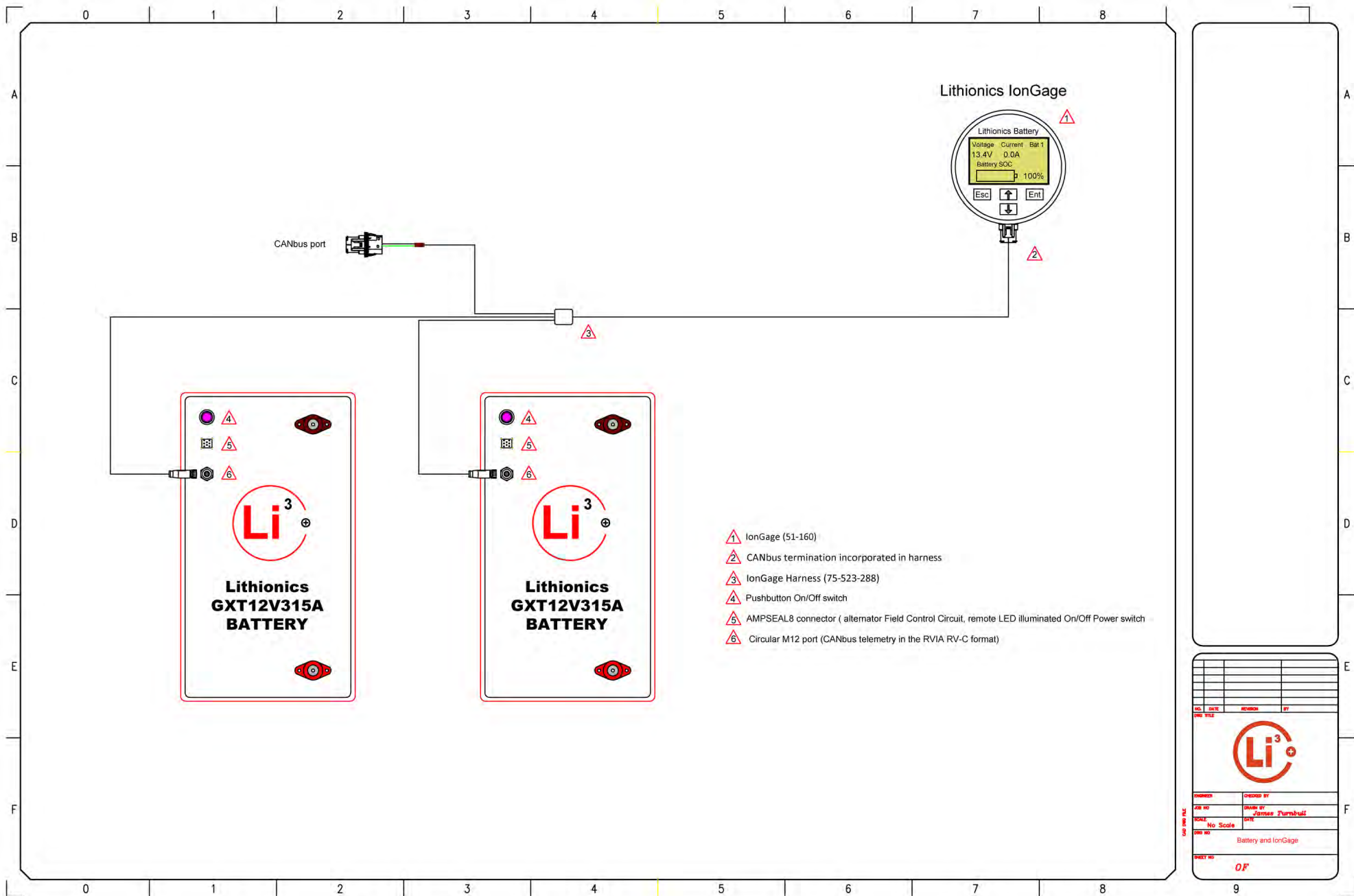

REV	DATE	REVISION	BY
DESIGNED BY	DESIGNED BY		
DRAWN BY	DRAWN BY James Furnball		
SCALE	SCALE 1:1		
TITLE	TITLE No Scale		
PART NO	PART NO Battery and IonGage		
QTY	QTY OF		



Parts List



QTY	PART NUMBER	DESCRIPTION	COMMENTS
1	BSS-2104	PowerBar 600A BusBar - Four 3/8"-16 Studs	Blue Sea Systems
1	BSS-2107	PowerBar 600A BusBar - Eight 3/8"-16 Studs	Blue Sea Systems
4	BSS-5006100	MAXI Fuse Block	Blue Sea Systems
2	BSS-5140	MAXI Fuse - 50 Amp	80A for Sterling BB1260
1	BSS-5139	MAXI Fuse - 40 Amp	Blue Sea Systems
1	BSS-5143	MAXI Fuse - 80 Amp	Blue Sea Systems
2	BSS-5191	MRBF Terminal Fuse Block - 30 to 300A	Blue Sea Systems
2	BSS-5007100	Class T Fuse Block with Insulating Cover - 110 to 200A	Blue Sea Systems
2	BSS-5190	MRBF Terminal Fuse - 300A	Blue Sea Systems
2	BSS-5116	Class T Fuse - 200 Amp	Blue Sea Systems
2	BSS-3000	HD-Series Heavy Duty On-Off Battery Switch	Blue Sea Systems
1	BSS-7138	187-Series Circuit Breaker - Surface Mount 40A	Blue Sea Systems, 48V max voltage
1	BB1230 12to12 30A	Sterling BB1230 12 to 12 30A	Optional BB1260 (60A)
1		Victron Multiplus Compact inverter/charger 12-3000-120	Victron
1		Victron Multi Controller GX	Victron
1		Victron Smart Solat MPPT 100/30	Victron
1	51-160	Lithionics IonGage	Lithionics Battery
1	75-523-288	IonGage Harness	Lithionics Battery

Battery Installation

Check the battery for visible damage including cracks, dents, deformation and other visible abnormalities. The top surface of the battery and terminal connections should be clean, free of dirt and corrosion, and dry.

Battery power should be turned off prior to the installation and for storage. Check the LED integrated into the Power button to make sure it is completely off. If the LED is on or blinking, press and hold the Power button for 3 seconds until LED turns off.

Lithium batteries do not release gas during normal use. There are no specific ventilation requirements for battery installation, although enough airflow should be provided to prevent excessive heat build-up.

The battery should be stored and installed in a clean, cool and dry place, keeping water, oil, and dirt away from the battery. If any of these materials can accumulate on the top surface of the battery, current leakage can occur, resulting in self-discharge and possible short circuits.



Battery Installation

The battery is equipped with two flat threaded terminals designed for a 5/16" or M8 size ring terminal lug and secured by included M8 bolts, flat washers and lock washers. When using flat washers, it is critical to place the ring terminal lug in direct contact with the top surface of the power terminal and then place the washers on top of the lug.

Connect the positive and negative battery cables with correct polarity and double check the polarity of battery circuit to avoid potential equipment and battery damage.

DO NOT place any washers between the battery power terminal and the ring terminal lug, as this could create a high resistance path and cause excessive heating of the connection which could then lead to permanent battery damage or fire. If you must attach more than one lug to each terminal, make sure at least 1/4" or 6mm of thread is available to secure the connection. Additionally, the ring terminal lugs need to be "clocked" in such a way that they do not interfere with their flat conducting surfaces. Acquire and use longer M8x1.25mm bolts if necessary.

Tighten both M8 power terminal bolts to a maximum of 108in-lbs/12.2Nm to ensure there is good contact with the ring terminal lug. Over tightening terminal connections can cause terminal breakage and loose connections can result in power terminal meltdown or fire.



Battery Installation

The battery cables should be sized to handle the expected load. Refer to NEC Table 310.15(B)16 for the maximum amperage based on the cable gauge size. Cable lengths in excess of 6 feet may require heavier gauge wire to avoid unacceptable voltage drop.

For more information refer to the National Electrical Code for correct cable size, which can be located at www.nfpa.org The battery circuit must be properly fused to handle the expected load and not to exceed the battery specifications.

After installation is complete, turn on the battery power by a short-press of the Power button. The LED indicator should come on to confirm the battery's state.

DO NOT connect multiple batteries in series to get higher voltage as it will damage the internal BMS.

DO NOT attempt to disassemble the battery, as it could lead to permanent battery damage and voids your battery warranty!!!



A link to the battery installation manual is listed at the back of this manual

Equipment Manuals

Please see below the web links for the manufacturer equipment manuals.

Lithionics Battery

Victron Inverter

Sterling Charger

Victron MPPT Solar Charger

