



Installer's Guide

GTX12V315A-E2107-CS200RV INSTALLATION KIT

XANTREX 2000 WATT

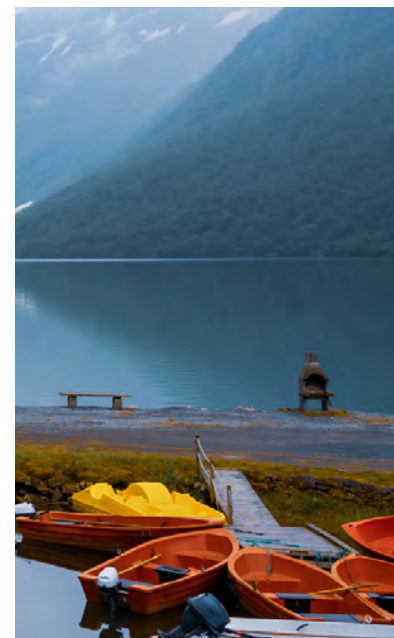
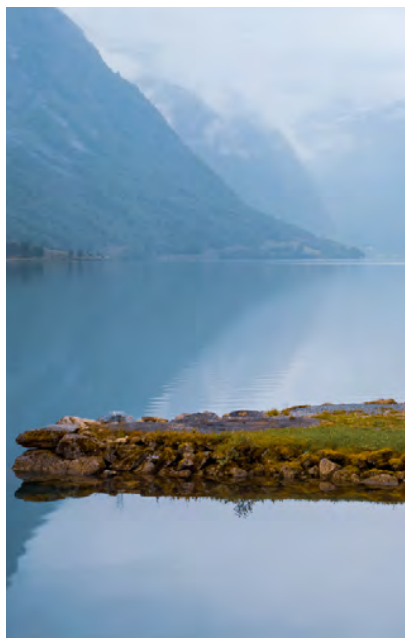
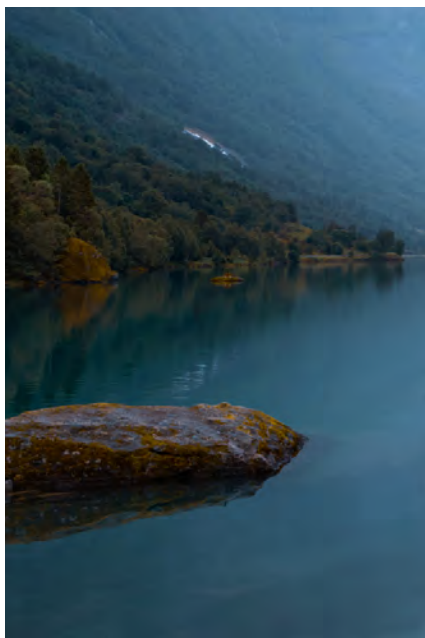

Table of Contents

SAFETY INFORMATION.....	1
INTRODUCTION.....	2
WIRING DIAGRAMS.....	3
MAIN DIAGRAM.....	4
INVERTER DIAGRAM.....	6
STERLING DIAGRAM.....	8
SOLAR DIAGRAM.....	10
BATTERY/IONGAGE DIAGRAM.....	12
PARTS LIST.....	14
BATTERY INSTALLATION.....	15
EQUIPMENT MANUALS.....	18





Safety Information

This manual is intended to be used by qualified installers. Although detailed, it is meant only as an overall guide to the installation and not to replace the manuals supplied by the relevant equipment manufacturers.

All electrical work should be performed in accordance with local and national electrical codes. Assume that voltage is present at the battery terminals, use insulated tools and gloves while working on the system. Always turn off equipment connected to the battery in addition to turning OFF the Power switch on the battery to isolate it from other electrical circuits before performing any repairs or maintenance on the system.

Always use proper wire sizes to connect the system to inverters, chargers or other equipment. Always use crimped connections to connect to the battery terminals. Read and follow the inverter, charger or other equipment manufacturers safety precautions prior to connecting the battery to that equipment. Always use charging equipment compatible with Lithium Iron Phosphate battery chemistry.

Links to the installation manuals relevant to this kit are listed at the back of this manual.

Introduction

The Lithionics **GTX12V315A-E2107-CS200 Xantrex** kit is based on a single **GTX12V315A-E2107-CS200** battery and a **Xantrex 2000 watt** inverter. The kit is limited to 300Amps DC. If a larger inverter or battery bank is anticipated in a future expansion then one of our larger kits with higher capacity components is recommended.

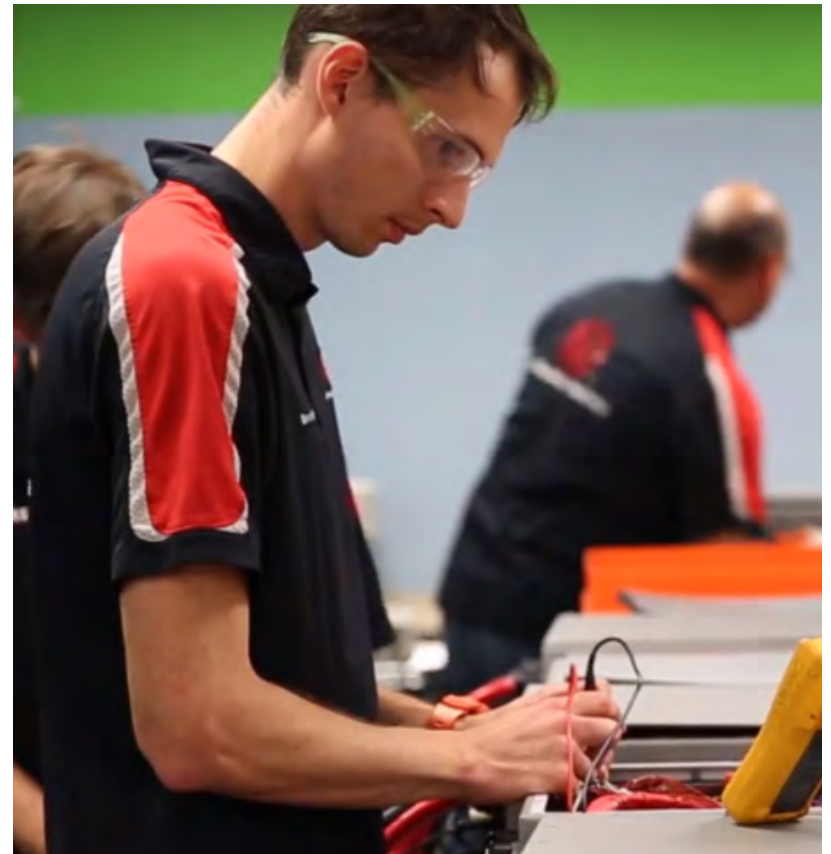

Wiring Diagrams

Main Diagram

Inverter Diagram

Sterling Diagram

Solar Diagram

Battery/IonGage Diagram



Main Diagram

The main diagram depicts the general layout of the system. The 4/0 positive cable is connected to the MRBF fuse block via a 300A post mounted fuse and an isolation switch. The inverter is connected to the non-fused post of the fuse block via a Class T 250A amp fuse and an isolation switch. The fuse should be mounted as close as possible to the fuse block. The isolation switch allows you to isolate the inverter in case of a malfunction as well as disabling the inverter if you need to work on the AC system. If the inverter is installed more than five feet from the fuse block, the wire size should be increased to 4/0 to compensate for voltage drop. The chassis DC grounding conductor (green) should be sized not less than one size smaller than the DC positive conductor and have a capacity such that the DC positive fuse has an amperage rating not greater than 135% of the current rating of this ground wire. If the 2/0 positive cable supplying the inverter shorts to ground internally, then the chassis ground cable needs to be able to carry enough current to blow the fuse without melting and possibly causing a fire.

The **Victron Smart** MPPT charger is connected to the positive distribution buss via a 40A fuse. The PV solar array is connected to the MPPT charger via a circuit breaker. The specified circuit breaker is only rated at 48VDC; if your PV solar array has an open circuit voltage that is higher, then another circuit breaker with a higher voltage rating must be substituted.

The **Sterling Battery to Battery** charger is connected to the main fuse block via a 50A fuse (80A for the BB1260 charger). It also has a fuse at the starter battery. This fuse must be installed as close to the battery as possible.

The **Lithionics IonGage** monitors battery voltage, current, power, amp-hours consumed and state of charge.

MAIN DIAGRAM

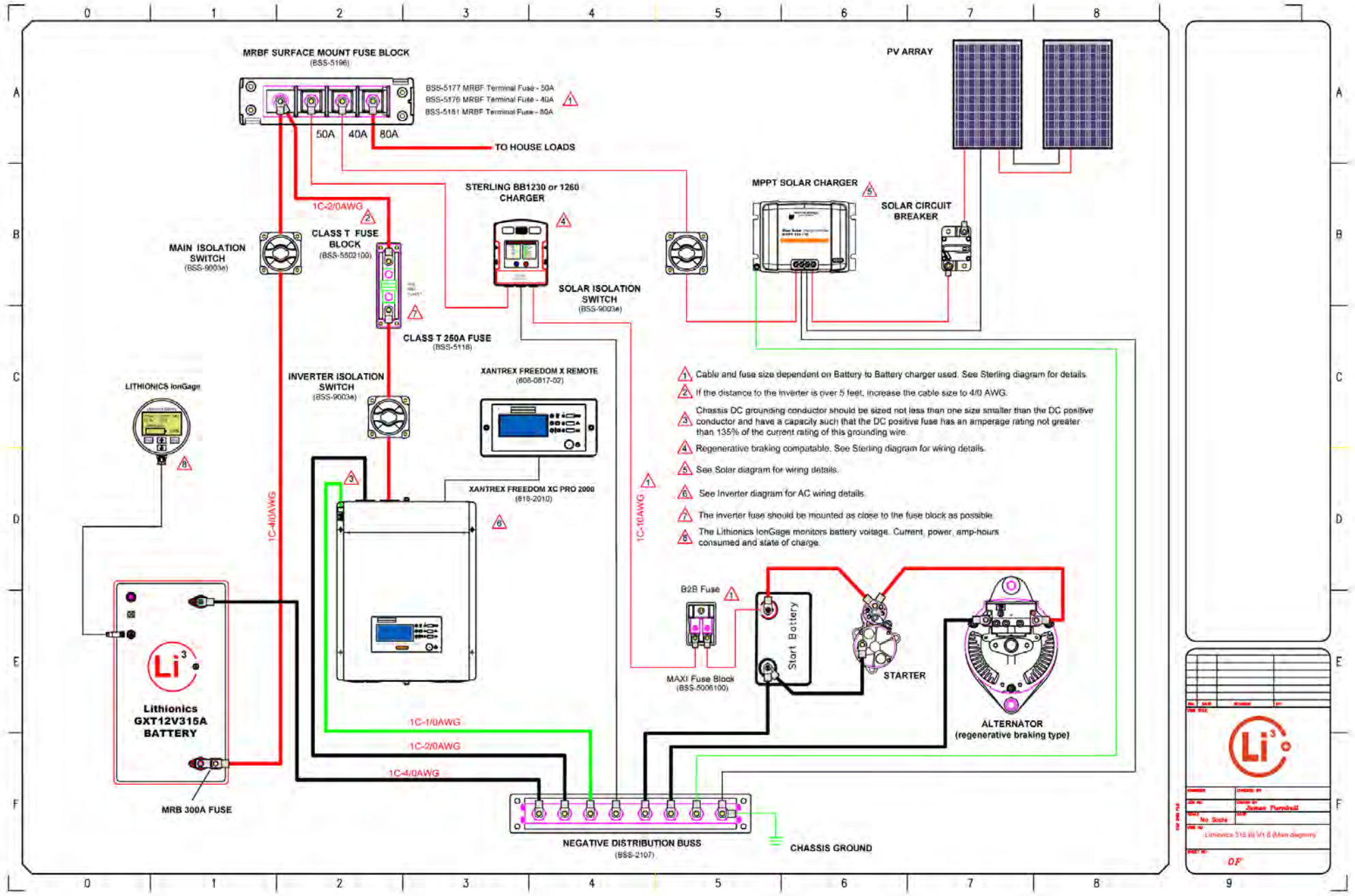

DATE	BY	REV
Li³		
DESIGNED BY	DRAWN BY	DATE
CHECKED BY		
Lithionics 315 Ah V1.0 (Main diagram)		
D.F.		

Inverter Diagram

The inverter diagram depicts a typical AC installation. The main panel has an output breaker for the non-inverter loads. It is used to power the high power loads beyond the inverters capacity such as a water heater or an electric stove. A 30A AC breaker supplies power to the inverter (mandatory). The wire supplying the inverter must be no smaller than 10AWG and have a temperature rating of not less than 75C. Make all connections using proper crimp-on connectors (do not use twist on connectors). The inverter output breaker should be rated at 30A. This breaker should be as close to the inverter as possible. If this breaker is not of the RCD (Residual Current Device) type, GFCI receptacles must be used at all AC outlets. In smaller installations you can install the optional GFCI receptacle (part #808-9817) on the front panel of the inverter; you can then plug loads of up to 20A directly into the inverter GFCI.

The Inverter is provided with a ground relay that automatically connects the neutral output to the chassis if no external AC supply is available. In an RV installation, the inverter chassis must be connected the vehicle chassis ground (via the negative distribution buss). The chassis grounding conductor must be not less than one size smaller than the DC positive conductor and have a capacity such that the DC positive fuse has an amperage rating not greater than 135% of the current rating of this grounding wire. When using an inverter sub panel, the inverter neutrals must return to the sub panel and not the main AC panel.

A warning label should be installed at the main AC panel to indicate that there is an inverter in the system.



Sterling Diagram

The **Sterling Battery to Battery charger** charges the house battery via the vehicles alternator. This system uses either the Sterling BB1230 charger (Mercedes recommendation), or the BB1260 charger depending on the size of the alternator. The charger should be programmed to charge the battery using a Lithium battery profile. The charger can also be set up to work with vehicles using regenerative braking.



Sterling Power Battery to Battery Charger 12V input to 12V output up to 60amps.



Sterling Power Battery to Battery Charger 12V input to 12V output 30amps

STERLING DIAGRAM

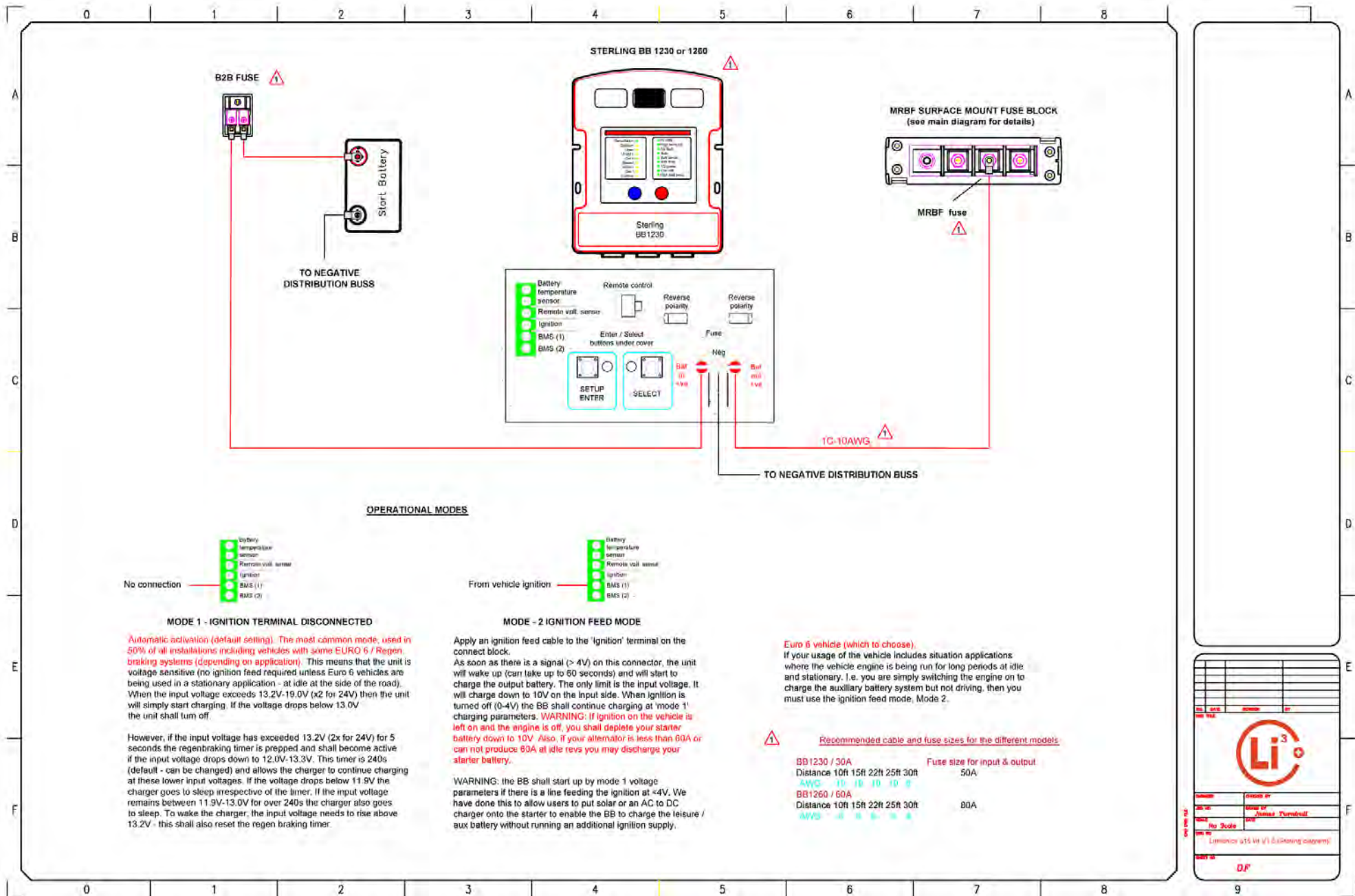

Solar Diagram

The **Victron Smart** MPPT solar charge controller uses maximum power point tracking which optimizes the match between the solar array and the battery bank. It converts the higher voltage DC output from the solar panels down to the lower voltage needed to charge the batteries. The PV solar array is connected to the MPPT charger with a circuit breaker (not supplied). The specified circuit breaker is only rated at 48VDC; if your PV solar array has an open circuit voltage that is higher, then another circuit breaker with a higher voltage rating must be substituted. The charger is connected to the positive distribution buss via a 40A fuse and an isolation switch.

The fuse and wire sizes are based on the Victron MPPT 100/30 charge controller, if a larger controller is used then the fuse and wire sizes should be increased as required. Using the **VictronConnect** App on your smartphone you can connect via Bluetooth and remotely control and monitor the Smart solar MPPT charger.



SOLAR DIAGRAM

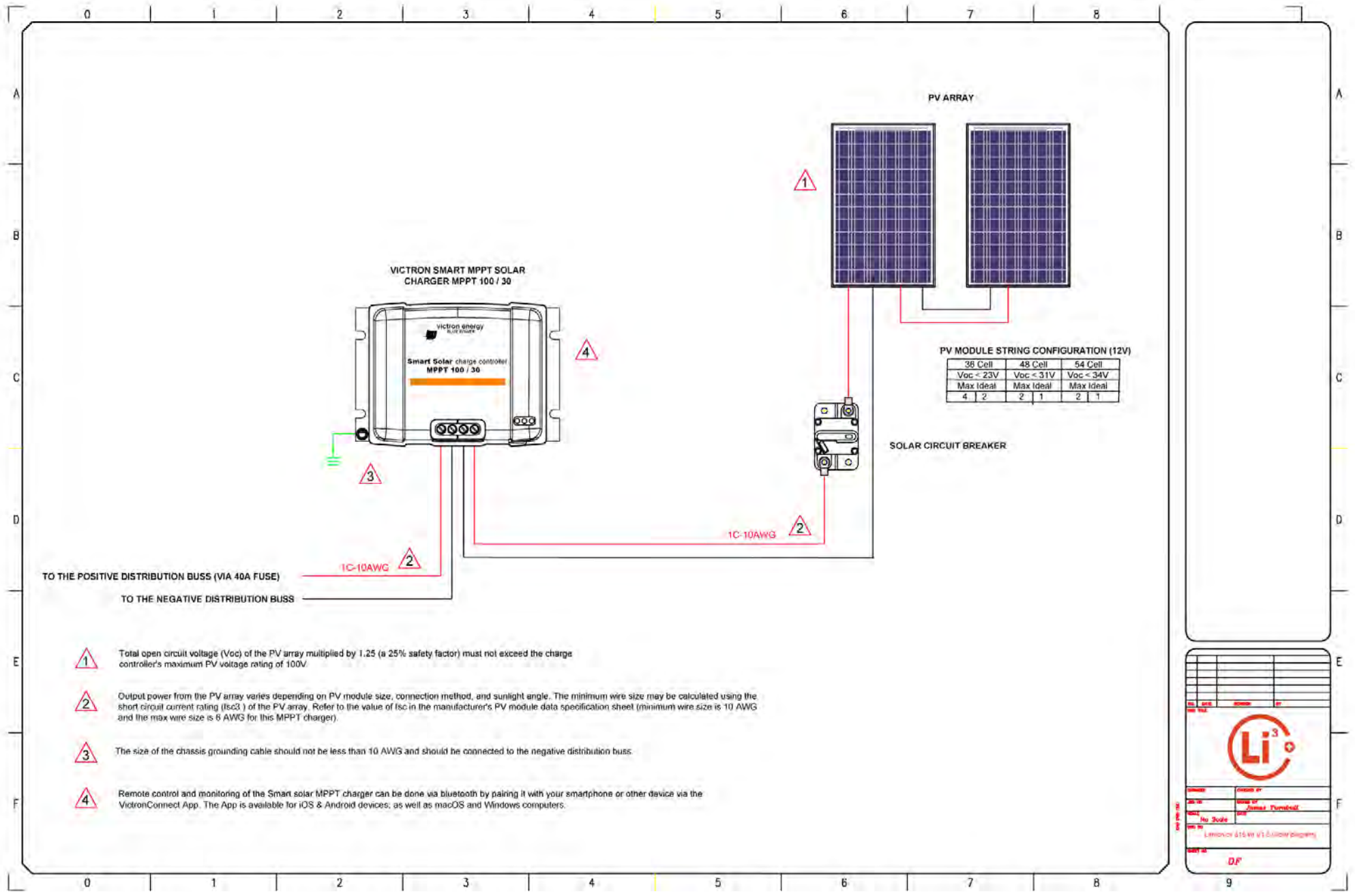

Battery/IonGage Diagram

The Advanced Series BMS includes an integrated SOC Gauge, designed to track battery state of charge (percent of usable energy left in the battery) as well as other useful data parameters. Tracking state of charge is accomplished by a Coulomb counter, based on an internal, high sensitivity hall-effect sensor. The SOC Gauge data will only be correct if the configuration parameters are set correctly, which are pre-set initially by Lithionics Battery, but are user adjustable with supporting hardware. The SOC Gauge will also track and display live amperage (A), live wattage (W), battery voltage (V), temperature (F/C), amp hours (Ah), watt hours (Wh), time remaining (d/h), etc. The meter will be most accurate if the battery is fully charged on a regular basis. If the battery is always partially charged, then the SOC meter reading may drift in the long term and will become less accurate. When the most accurate measurements are required it is recommended to perform a full charge at least weekly.



BATTERY/IONGAGE DIAGRAM

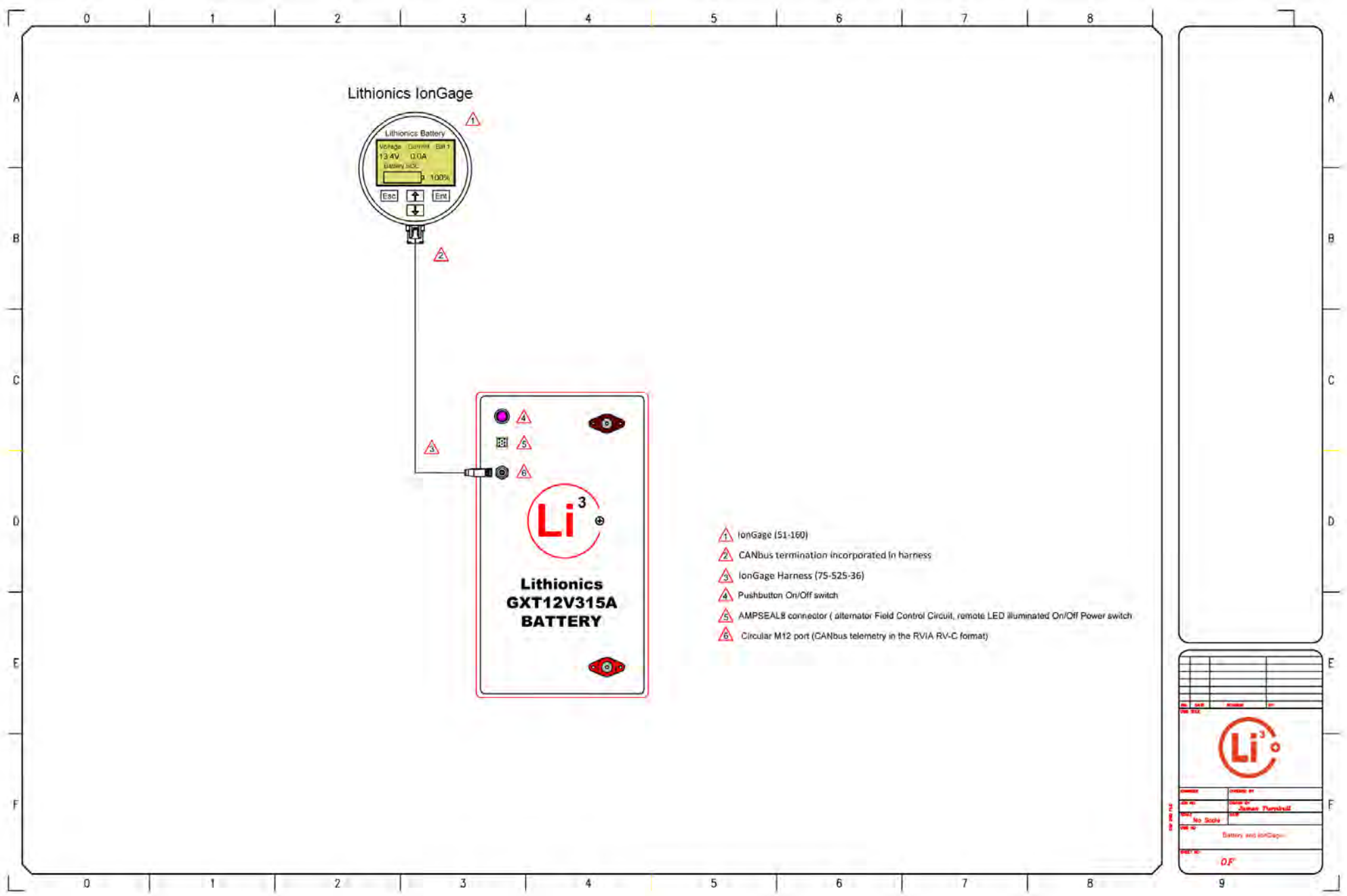

- 1 IonGage (51-160)
- 2 CANbus termination incorporated in harness
- 3 IonGage Harness (75-525-36)
- 4 Pushbutton On/Off switch
- 5 AMPSEAL8 connector (alternator Field Control Circuit, remote LED illuminated On/Off Power switch
- 6 Circular M12 port (CANbus telemetry in the RVIA RV-C format)

DATE	TIME	MILEAGE	STATE	SOC
01/01/2018	12:00	0	FL	100%

Battery and IonGage...

D.F.



Parts List



QTY	PART NUMBER	DESCRIPTION	COMMENTS
1	BSS-5177	MRBF Terminal Fuse - 50A	80A for Sterlin BB1260
1	BSS-5176	MRBF Terminal Fuse - 40A	Blue Sea Systems
1	BSS-5181	MRBF Terminal Fuse - 80A	Blue Sea Systems
1	BSS-5191	MRBF Terminal Fuse Block- 30 to 300A	Blue Sea Systems
1	BSS-5190	MRBF Terminal Fuse - 300A	Blue Sea Systems
1	BSS-5196	MRBF Surface Mount Fuse Block- Common Source	Blue Sea Systems
1	BSS-5502100	Class T Fuse Block with Insulating Cover- 225 to 400A	Blue Sea Systems
1	BSS-5118	Class T Fuse - 250 Amp	Blue Sea Systems
1	BB1230 12to12 30A	Sterling BB1230 12 to 12 30A	Optional BB1260 (60A)
3	BSS-9003e	E-Series On, Off Battery Switch	Blue Sea Systems
1	818-2010	Freedom XC PRO 2000 12V	
1	808-0817-02	Freedom X Bluetooth Remote Panel	
1		Victron Smart Solar MPPT 100/30	Victron
1	BSS-7138	187-Series Circuit Breaker - Surface Mount 40A	Blue Sea Systems, 48V max voltage
1	BSS-5006100	MAXI Fuse Block	Blue Sea Systems
1	BSS-5140	MAXI Fuse - 50 Amp	80A for Sterlin BB1260
1	BSS-2107	PowerBar 600A BusBar - Eight 3/8"-16 Studs	Blue Sea Systems
1	51-160	Lithionics IonGage	Lithionics Battery
1	75-525-36	IonGage Harness	Lithionics Battery

Battery Installation

Check the battery for visible damage including cracks, dents, deformation and other visible abnormalities. The top surface of the battery and terminal connections should be clean, free of dirt and corrosion, and dry.

Battery power should be turned off prior to the installation and for storage. Check the LED integrated into the Power button to make sure it is completely off. If the LED is on or blinking, press and hold the Power button for 3 seconds until LED turns off.

Lithium batteries do not release gas during normal use. There are no specific ventilation requirements for battery installation, although enough airflow should be provided to prevent excessive heat build-up.

The battery should be stored and installed in a clean, cool and dry place, keeping water, oil, and dirt away from the battery. If any of these materials can accumulate on the top surface of the battery, current leakage can occur, resulting in self-discharge and possible short circuits.



Battery Installation

The battery is equipped with two flat threaded terminals designed for a 5/16" or M8 size ring terminal lug and secured by included M8 bolts, flat washers and lock washers. When using flat washers, it is critical to place the ring terminal lug in direct contact with the top surface of the power terminal and then place the washers on top of the lug.

Connect the positive and negative battery cables with correct polarity and double check the polarity of battery circuit to avoid potential equipment and battery damage.

DO NOT place any washers between the battery power terminal and the ring terminal lug, as this could create a high resistance path and cause excessive heating of the connection which could then lead to permanent battery damage or fire. If you must attach more than one lug to each terminal, make sure at least 1/4" or 6mm of thread is available to secure the connection. Additionally, the ring terminal lugs need to be "clocked" in such a way that they do not interfere with their flat conducting surfaces. Acquire and use longer M8x1.25mm bolts if necessary.

Tighten both M8 power terminal bolts to a maximum of 108in-lbs/12.2Nm to ensure there is good contact with the ring terminal lug. Over tightening terminal connections can cause terminal breakage and loose connections can result in power terminal meltdown or fire.



Battery Installation

The battery cables should be sized to handle the expected load. Refer to NEC Table 310.15(B)16 for the maximum amperage based on the cable gauge size. Cable lengths in excess of 6 feet may require heavier gauge wire to avoid unacceptable voltage drop.

For more information refer to the National Electrical Code for correct cable size, which can be located at www.nfpa.org The battery circuit must be properly fused to handle the expected load and not to exceed the battery specifications.

After installation is complete, turn on the battery power by a short-press of the Power button. The LED indicator should come on to confirm the battery's state.

DO NOT connect multiple batteries in series to get higher voltage as it will damage the internal BMS.

DO NOT attempt to disassemble the battery, as it could lead to permanent battery damage and voids your battery warranty!!!



A link to the battery installation manual is listed at the back of this manual

Equipment Manuals

Please see below the web links for the manufacturer equipment manuals.

Lithionics Battery

Xantrex Inverter

Sterling Charger

Victron MPPT Solar Charger

