

LITHIONICS BATTERY®

LITHIUM ION IRON PHOSPHATE BATTERY SYSTEMS



MODEL NUMBER:
GTX12V630A-F24-DIN-MODULE-UL

EXTERNAL BMS
VERSION



EXTERNAL BMS REQUIRED

BMS SOLD SEPARATELY. SEE BMS
DATA SHEET PROVIDED BY LITHIONICS
BATTERY®.

Item	Description
Model	GTX12V630A-F24-DIN-MODULE-UL
Nominal Voltage	12.8
Nominal Capacity	630
Nominal Watt Hours	8064
Internal Resistance	<300 milliohms
Charge	
Charging temperature range	32F/0C to 131F/55C
Charge voltage	14.6
Recommended float charge voltage(for standby use)	13.4
Recommended max charge current*	300
Allowed max charge current*	400
Discharge	
Discharging temperature range	-4F/-20C to 131F/55C
Operating Voltage Range	11.6 to 13.4
Recommended max discharge current*	300
Max discharge current*	400
Pulse discharge current	6300
Discharge cut-off voltage	NeverDie® Power Reserve @ 12.00 Low-Voltage Cut-Off @ 11.60
Mechanical	
Dimensions	Length 24.0" Width 13.0" Height 11.1"
Weight	Approx. 144lbs (65.3kg)
Storage	
Storage Temperature & Humidity Range	< 1 Month -4~95°F (-20~35°C), 45~75%RH < 3 Months 14~86°F (-10~30°C), 45~75%RH Recommended storage 59~95°F (15~35°C), 45%RH~75%RH
Long Term Storage	If the battery needs to be stored for > 3 months the voltage should be 13.2V (50%SOC), and stored at the recommended storage specifications shown above. Additionally, the battery needs at least one charge & discharge cycle every six months.
Self-discharge rate	Residual capacity ≤3% per month; ≤15% per year Reversible capacity ≤1.5%per month; ≤8% per year

* Maximum charging and discharging rates apply depending upon the ambient temperature and duty cycle of the system. UL1973 tests of maximum charge and discharge current were performed at 25°C/77°F



NEVERDIE®

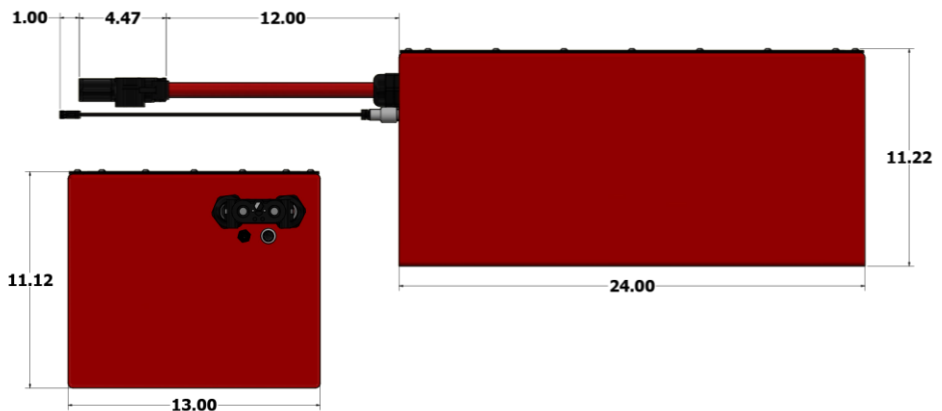

ENERGY

630 AMP HOURS

PULSE AMPS: 6300 (1 SEC)

8064 WATT-HOURS

WARNING

1. LITHIUM BATTERIES ARE NOT DESIGNED FOR CHARGING IN SUB-FREEZING TEMPERATURES. CONTACT LITHIONICS BATTERY® FOR DETAILS ON OUR COLD WEATHER PACKAGE.
2. INSTALLATION: IT IS RECOMMENDED THAT BATTERIES BE INSTALLED CABLE OR TERMINAL SIDE UP.

NOTE: CONTACT LITHIONICS BATTERY® FOR A USER INSTALLATION GUIDE & STORAGE PROCEDURES. FOLLOW THE GUIDE TO ENSURE FITNESS OF USE & WARRANTY.

**12V
GTX
SERIES**